

# A Multi-Channel Token Ring Protocol for QoS Provisioning in Inter-Vehicle Communications

Yuanguo Bi, Kuang-Hao Liu, Lin X. Cai, Xuemin (Sherman) Shen, *Fellow, IEEE*, and Hai Zhao

**Abstract**—This paper proposes a multi-channel token ring media access control (MAC) protocol (MCTRP) for inter-vehicle communications (IVC). Through adaptive ring coordination and channel scheduling, vehicles are autonomously organized into multiple rings operating on different service channels. Based on the multi-channel ring structure, emergency messages can be disseminated with a low delay. With the token based data exchange protocol, the network throughput is further improved for non-safety multimedia applications. An analytical model is developed to evaluate the performance of MCTRP in terms of the average full ring delay, emergency message delay, and ring throughput. Extensive simulations with ns-2 are conducted to validate the analytical model and demonstrate the efficiency and effectiveness of the proposed MCTRP.

**Index Terms**—Intelligent transportation system, inter-vehicle communications, token ring, multi-channel MAC.

## I. INTRODUCTION

WITH the rapid development of communication and networking technologies, vehicular ad-hoc network (VANET) has been emerging to enable new mobile services and applications including vehicular safety applications (e.g., collision, congestion, or injury warning and reporting) and non-safety multimedia applications (e.g., Internet access, media streaming, and online gaming) [1]. Generally, vehicular communications can be classified into two categories: inter-vehicle communications (IVC) and roadside-to-vehicle communications (RVC) [2]–[4]. In the IVC system, information is exchanged between vehicles, while in a RVC system, vehicles communicate with the roadside unit (RSU). Compared with RVC system which is dependent on the roadside infrastructure, IVC system can operate autonomously in an ad-hoc mode and is more flexible, rendering more attractive vehicular related applications. However, the lack of infrastructure support,

high mobility of vehicles, and dynamic topology changes make efficient resource management in VANET extremely challenging. In addition, various applications have different QoS requirements. For instance, safety related applications demand quick and reliable message delivery, while non-safety applications usually require high throughput and good fairness performance. Therefore, it is very important to design an efficient MAC protocol in IVC system to meet different QoS requirements of vehicular applications in VANET.

Token ring protocols have attracted much attention from wireless communication communities due to their QoS provisioning in terms of reserved bandwidth and bounded delay. Wireless token ring protocol (WTRP) was proposed for Intelligent Transportation systems (ITS) [5] and first deployed in Partners for Advanced Transit and Highways (PATH) vehicle safety systems program [6]. To the best of our knowledge, existing token ring protocols are mainly based on a single communication channel. For efficiently utilizing the network resources of VANET, the multi-channel structure should be considered.

In this paper, we propose a multi-channel token ring MAC protocol (MCTRP) for vehicular networks. We employ the multi-channel structure defined in IEEE 802.11p in the protocol design. Through effective ring coordinations and dynamic channel scheduling, vehicles can be autonomously organized into multiple rings operating on different service channels. The asynchronous CSMA/CA mechanism is applied for emergency message exchange, which provides satisfactory delay performance under low traffic load and contention level. To further improve the throughput performance of non-safety multimedia applications, we present a token-based data exchange protocol which ensures high resource utilization of wireless channels.

The main contributions of the paper are three-fold. First, we propose a novel multi-channel token ring protocol for VANET, considering the particular features of vehicular networks, including no infrastructure support, dynamic topology changes due to high mobility, hostile wireless transmission environment, etc. Second, we develop an analytical model to study the performance of MCTRP, e.g., average full ring delay, average emergency message delay, average ring throughput, and average access delay, etc. Third, extensive simulations with ns-2 are conducted to verify the analysis and demonstrate the efficiency and effectiveness of the proposed protocol.

The remainder of this paper is organized as follows. In Section II, we briefly review the related work. The system model is introduced in Section III. The proposed MCTRP is described in Section IV. In Section V, we present an analytical model to study the performance of the proposed MCTRP. Numerical results are given in Section VI, followed

Manuscript received December 17, 2008; revised March 26, 2009 and May 26, 2009; accepted July 11, 2009. The associate editor coordinating the review of this paper and approving it for publication was P. Fan.

Part of this paper was presented at IEEE GLOBECOM'08.

Y. Bi is with the Department of Computer Science and Technology, Northeastern University, Shenyang, China 110004, and is a visiting Ph.D. student with the Department of Electrical and Computer Engineering, University of Waterloo, Waterloo, Ontario, Canada N2L 3G1 (e-mail: ygbi@bbr.uwaterloo.ca).

X. Shen and L. X. Cai are with the Department of Electrical and Computer Engineering, University of Waterloo, Canada N2L 3G1 (e-mail: {xshen, lcai}@bbr.uwaterloo.ca).

K. Liu is with the Department of Electrical Engineering, National Cheng Kung University, Tainan, Taiwan 70101 (e-mail: khliu@mail.ncku.edu.tw).

H. Zhao is with the Department of Computer Science and Technology, Northeastern University, Shenyang, China 110004 (e-mail: zh-hai@neuera.com).

This work was supported in part by the Cultivation Fund of the Key Scientific and Technical Innovation Project, Ministry of Education of China (NO. 708026), and the Natural Sciences and Engineering Research Council (NSERC) of Canada.

Digital Object Identifier 10.1109/TWC.2009.081651

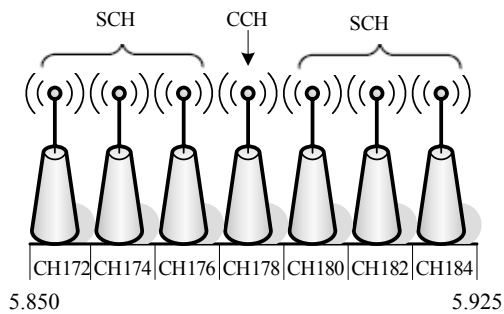

Fig. 1. Multi-channel structure.

by concluding remarks and future work in Section VII.

## II. RELATED WORK

The U.S. Federal Communications Commission (FCC) has approved 75 MHz frequency band for ITS wireless communications. As shown in Fig. 1, the frequency between 5.850 – 5.925 GHz is divided into seven channels in [7]. One of the seven channels, CH178, is designated as the control channel (CCH) which is used for high priority message exchanges, such as safety related applications, system control and management. The other six channels are used as service channels (SCH) which support non-safety applications. Based on the multi-channel structure defined by the FCC, several MAC protocols have been proposed for VANET. In [8], the vehicular mesh network (VMESH) MAC protocol applies a reserved TDMA scheme to improve network throughput. VMESH further partitions the CCH into a beacon period (BP) and a safety period (SP). The BP is divided into multiple slots and each vehicle chooses a unique beacon slot to broadcast its control information. By employing the beacon-enabled MAC, each vehicle is able to keep awareness of its neighbors and coordinate resource allocation in the SCHs. Therefore, the bandwidth is efficiently shared among vehicles, and high network throughput can be achieved. However, VMESH mainly focuses on throughput performance, without considering other QoS performance (e.g., delay) of safety applications. In [9], a cluster based multi-channel MAC protocol is proposed to provide quick emergency message dissemination and bounded delay. However, due to the lack of efficient topology control mechanism, the cluster-based approach is more suitable for VANET with less topology variation. Some other multi-channel MAC protocols are proposed for general wireless networks. For example, the Dynamic Channel Assignment (DCA) in [10] requires each node be equipped with two radios, where one radio is dedicated to control message exchange, and the other is for data message exchange. The adoption of multiple channels is helpful to reduce the co-channel interference between the two radios, but it is very difficult to fully utilize the radio resource in both channels due to the inefficient coordination between them.

On the other hand, many studies on token or ring structure based MAC protocols have appeared in the literature. Wireless token ring protocol (WTRP) is proposed in [5] to provide bounded delay and fairness to nodes for data communications without considering the special safety-related applications in

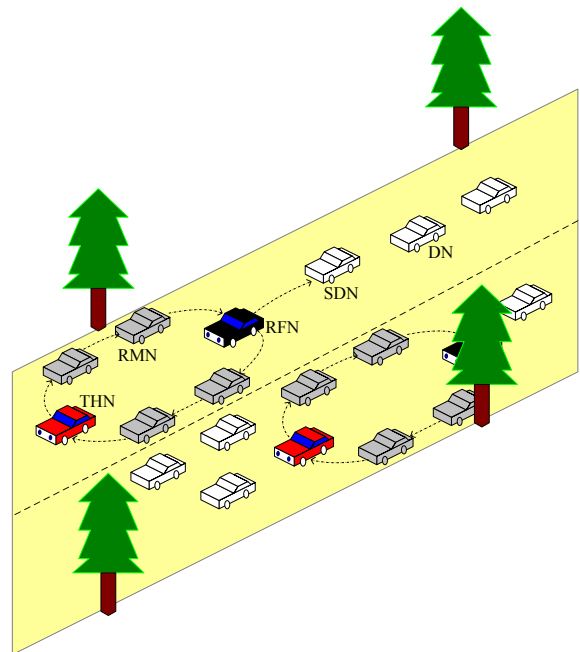

Fig. 2. Different types of vehicles in the proposed MCTRP.

VANET. In [11], a token based control scheme is presented to emulate the window-based flow and congestion control in wireless/wired Networks. In [12], a token based scheme is presented to ensure guaranteed priority for voice traffic in single-hop networks. In [13], an overlay token ring protocol (OTRP) is proposed for IVC, and it operates in two modes. In the ordinary mode, a token circulates along the ring, and each vehicle has the same opportunity to transmit their data packets by holding the token for the same time interval. In case of accidents, it changes to emergency mode in which the emergency messages are delivered to all nearby nodes. By adopting the token and different operation modes, OTRP is capable of supplying stringent throughput and rapid emergency message delivery. Nevertheless, OTRP uses single channel architecture, and does not consider interference among multiple rings. The MAC protocols in [14]–[16] mainly focus on safety applications in VANET. But they cannot guarantee quick and reliable emergency delivery and high throughput data transmission simultaneously. As far as we investigate, our work is the first to jointly consider the different QoS requirements of safety-related applications and the high volume data applications in IVC, based on the token ring and the multi-channel structure specified by the FCC.

## III. SYSTEM MODEL

We consider a vehicle network where one or multiple *virtual rings* are dynamically formed according to the velocities of vehicles and road traffic conditions. The maximum number of vehicles in a ring is referred to as the ring size  $N_{\max}$ . As shown in Fig. 2, nodes (the terms “node” and “vehicle” are used interchangeably throughout the paper, and important symbols are summarized in Table I) in the system can operate on different states as follows.

- 1) **ring founder node (RFN)**: a node that initially sets up a ring (details will be given in Sec. IV-A) and has the

TABLE I  
 SUMMARY OF IMPORTANT SYMBOLS

Symbol	Definition	Symbol	Definition
CCH	control channel	SCH	service channel
RFN	ring founder node	THN	token holder node
RMN	ring member node	DN	dissociative node
SDN	semi-dissociative node	EM	emergency message
RFM	ring founding message	JIM	joining invitation message
JAM	joining acknowledgement message	CNM	connection notification message
CSM	connecting successor message	CAM	connection acknowledge message
JSM	joining success message	ANM	address notification message
IADB	intra-ring data buffer	IRDB	inter-ring data buffer
$T$	the ring period	$T_s$	the safety period
$T_c$	the coordination period	$T_d$	the data exchange period
$T_{MTH}$	maximum token holding time	$T_{retry}$	maximum retransmission times
$t_{sifs}$	SIFS interval	$t_{difs}$	DIFS interval
$\eta$	the value set by token passing timer	$\rho$	time slot
$L_{em}$	size of the emergency message	$L_d$	size of the data packet
$N_{max}$	maximum number of RMNs in a ring	$e_j$	the steps for a ring to be full from the state $j$
$t_s$	the delay for transmitting an EM from a RMN to its RFN	$t_r$	the delay for a RFN broadcasting an EM to its RMNs
$F_i$	the set of neighboring RFNs of $i$	$D_i$	the set of neighboring DNs and SDNs of $i$
$N_i$	the set of RMNs in the same ring with node $i$	$N_f$	the set of saturated RMNs in the ring
$\vec{N}_f$	the set of un-saturated RMNs in the ring	$\gamma_i$	the probability that a node $i$ randomly selects a time slot
$\tau_i$	the probability that node $i$ transmits a packet successfully	$\varphi$	the propagation delay on the channel
$t_m$	the delay for a RFN broadcasting an EM to its neighboring RFNs, DNs and SDNs	$\theta_i$	the probability that at least one neighboring node selects the same slot with $i$
$p_j$	the joint probability that a DN joins the ring and no RMN leaves the ring	$q_j$	the joint probability that one RMNs leaves the ring and no DN joins the ring

authority to cancel a ring. The RFN is also responsible for adding new nodes into the ring and deleting nodes from the ring.

- 2) **token holder node (THN)**: a node which is in a ring and holds a token.
- 3) **ring member node (RMN)**: a node which is in a ring, but does not hold a token.
- 4) **dissociative node (DN)**: a node which does not belong to any ring, and does not start the joining process.
- 5) **semi-dissociative node (SDN)**: a node which receives the joining invitation and connection notification messages from the RFN and is ready to connect to its successor.

The state transition diagram is shown in Fig. 3. A DN becomes a RFN after it sets up a ring successfully. A DN becomes a SDN when it successfully receives a joining invitation from a RFN and starts to join the ring. If the joining procedure completes within a constant period, a SDN turns to be a RMN; otherwise, a SDN becomes a DN. A RMN becomes a DN if it is deleted from the ring or the ring is cancelled by the RFN, and becomes a THN after receiving a token. Note that both RFNs and THNs are special types of RMNs.

In the system, all vehicles are equipped with two radios, e.g., Radio-I and Radio-II. All DNs operate over CH178 using Radio-I only, while other types of nodes can simultaneously operate over CH178 with Radio-I and one of the six SCHs with Radio-II, as shown in Fig. 1. Time in the system is

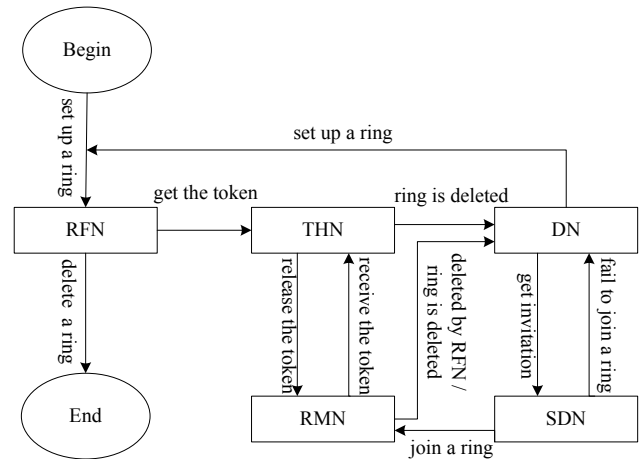

Fig. 3. State transition diagram.

synchronized with the aid of GPS and partitioned into fixed time periods of a duration  $T$  composed of a control period and a data period, which are further divided into safety period  $T_s$ , ring coordination period  $T_c$  and data exchange period  $T_d$  as depicted in Fig. 4. The detailed description of each period will be presented in Sec. IV.

#### IV. MULTI-CHANNEL TOKEN-RING PROTOCOL

To provide different QoS performance and achieve efficient resource utilization, the proposed MCTRP employs three sub-protocols as follows.

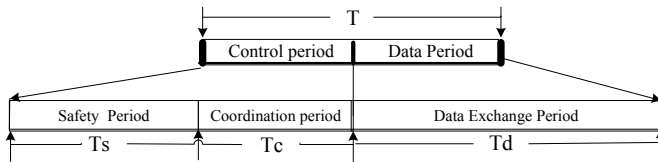

Fig. 4. Timing structure.

- 1) **Ring coordination protocol** is designed for ring management including setting up or dismissing a ring, admitting new nodes to the ring, deleting nodes from the ring, and scheduling SCHs for each ring.
- 2) **Emergency message exchange protocol** is responsible for collecting emergency messages in a ring, and delivering them to other rings.
- 3) **Data exchange protocol** controls the token delivery in a ring for efficient intra-ring data communications.

#### A. Ring Coordination Protocol

The ring coordination protocol includes ring initiation process, node joining process, node leaving process, ring updating process, and ring termination process.

**Ring Initialization Process** – When a DN declares to set up a ring, it broadcasts the ring founding message (RFM) to the nearby nodes in the  $T_c$  interval with Radio-I, and starts a ring founding timer. The RFM also includes the selected SCH number for the intra-ring data communications. If the SCH number has been occupied by another ring in its neighborhood, the RFN of the neighboring ring using this SCH will invite the DN to join the existing ring provided the number of the RMNs is less than  $N_{max}$ . Otherwise, the RFN will simply notify the DN to re-select a SCH, and the DN will re-initiate the ring initialization process. The re-initialization process continues until all the six SCHs are occupied by neighboring rings, in which case the DN will stop broadcasting its RFMs, and keep monitoring the control channel with Radio-I until it is admitted into a ring. If the DN has not received any response until the ring founding timer expires, the DN creates a ring and becomes a RFN, which opens its Radio-II and operates on the selected SCH.

**Joining Process** – After a ring has been established, the RFN will broadcast the joining invitation message (JIM) using Radio-I in each  $T_c$  after a random backoff, if the number of RMNs in the ring is less than  $N_{max}$ . The broadcast JIM includes the moving speed of the RFN, the selected SCH number, the amount of the current RMNs, the expected lifetime of the ring, and time period  $T$ ,  $T_s$ ,  $T_c$ ,  $T_d$ . A DN receiving the JIM will compare its moving speed with that of the RFN. If the difference is smaller than a predefined speed threshold,  $v_d$ , the DN will reply the RFN a joining acknowledgement message (JAM) using Radio-I after a random backoff. The  $v_d$  is used to ensure that there is comparatively small speed difference between nodes within the same ring. When a DN receives multiple JIMs, it will choose to join the ring with the least speed difference. Therefore, the topology of a ring is relatively stable and the ring management overhead can be significantly reduced. After receiving a JAM, the RFN replies a connection notification message (CNM) to the DN that first responds,

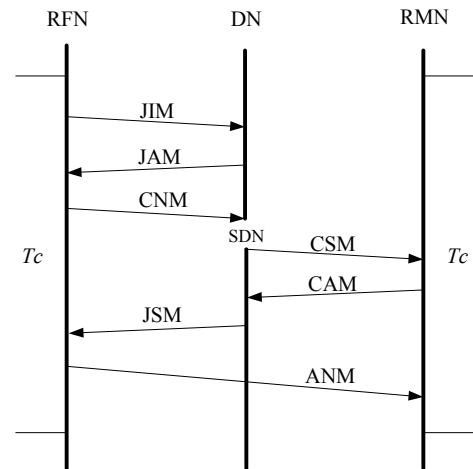

Fig. 5. Illustration of the joining process.

indicating the MAC address of the successor that the DN should connect to. If all messages are exchanged successfully, the DN becomes a SDN and then opens its Radio-II to the specified SCH in JIM. The SDN then sends a connecting successor message (CSM) to its successor with Radio-II. If the SDN receives a connection acknowledge message (CAM), it will transmit a joining success message (JSM) to the RFN, which includes its valid time in the ring. The RFN always takes the newly joined RMN as its default successor. Thus, the new RMN successfully joins the ring if it can connect to its successor in the joining process. After receiving a JSM, the RFN will broadcast an address notification message (ANM) that contains all the MAC addresses of RMNs in the ring, so that each RMN can keep its ring information. All the packet exchanges in the joining process are shown in Fig 5.

The communications in the  $T_c$  employ the contention based CSMA/CA scheme for efficient control message exchange. Notice that it is possible some messages in the joining process may be lost due to collisions or corrupted in a wireless fading channel. If the RFN can not successfully receive the JSM at the end of  $T_c$ , it will delete the SDN information, and the SDN will return to the DN state. To reduce potential collisions caused by hidden terminal problem, some control messages, including JAM, CNM, and CSM, contain a time field representing the time duration that the node will occupy the channel, and other nodes which overhear them update their network allocation vector (NAV) and postpone their channel access accordingly.

**Leaving Process** – Three cases can trigger the leaving process. First, each node reports to the RFN its valid time in the ring in JSM. In each  $T_c$ , the RFN checks the MAC information base (MIB) for the time record and deletes the node if its valid time expires. Second, if a THN can not pass the token to its successor after several attempts, it will consider the successor has left the ring and report this to the RFN. Third, each THN will pass the token to its successor by broadcasting, and the RFN will also record the THN on receiving the broadcast token, which implies the THN is still in the ring. After the token circulates the ring for a cycle, the RMNs that can't be heard by the RFN will be deleted in

the  $T_c$  period. The RFN will notify its RMNs to update local ring information after deleting the departure node, and the predecessor and successor of the departure node will connect to each other consequently. Note that a node may be deleted if it is isolated from the ring due to deep fading for a long time. If a node does not receive any message from its predecessor and the RFN for a certain period, or it finds it is not included in the list of MAC addresses of RMNs, it will return to the DN state.

**Ring Updating Process** – The RFN needs to update the ring setting information when some changes occur. For example, the RFN needs to select another SCH if the co-channel interference on the current SCH becomes overwhelming for intra-ring data communications. This is possible in highly mobile vehicle networks. In the initialization process, two or more rings may choose the same SCH because they are out of each other's transmission range. However, due to the mobility, these rings may move into each other's interference range or even transmission range, which causes serious co-channel interference to each other. The following cases will lead to the ring updating.

- During  $T_c$  interval, the RFN broadcasts a JIM which includes the SCH number of the ring with Radio-I, if the number of its RMNs is less than  $N_{\max}$ . If a neighboring RFN overhears the message and finds the selected SCH overlaps with its own SCH, it will communicate with the RFN using Radio-II. Otherwise, if the number of RMNs has reached  $N_{\max}$ , there will be no JIM broadcasting, and instead the RFN will broadcast a message containing its SCH number in each  $T_c$  interval. The neighboring RFN that operates on the same SCH will also communicate the sender with Radio-II. The ring which has a smaller number of RMNs will notify its RMNs to stop data transmission on the overlapped SCH and search a free SCH for its intra-ring communications. If a clear SCH is detected, it will broadcast a changing channel notification message (CCNM) including the new SCH. All RMNs will change their SCH on Radio-II upon receiving the CCNM. Otherwise, the ring has to be terminated and all RMNs become DNs.
- If a THN detects a busy SCH in the data exchange process, which implies that two neighboring rings use the same SCH, it will hold the token and stop the data transmission. In the next  $T_c$ , it broadcasts a SCH overlapped message including the number of current RMNs in its ring denoted as  $|N_i|$  with Radio-II. A RMN that operates on the same SCH with Radio-II in another ring overhears the message, and compares its  $|N_i|$  with that of the sender. If its  $|N_i|$  is larger than that of the sender, it will reply the sender, and the sender then notifies its RFN to switch SCH. Otherwise, the RMN will notify its RFN to switch SCH. The RFN that receives a SCH switch notification from its RMN will select another SCH and broadcast a CCNM to its RMNs. The message exchanges during  $T_c$  period use contention-based CSMA/CA mechanism.
- A RFN may change the speed or the expected ring lifetime that is declared in JIM in the course of moving, and it will broadcast the updated information to its RMNs during the period  $T_c$ . Those RMNs that do not accept

the speed or time will notify the RFN and leave the ring. A RMN may also update the valid time declared in JSM, and report it to its RFN within  $T_c$ . After receiving these messages, the RFNs can update the ring information accordingly for efficient ring management.

**Ring Termination Process** – When the lifetime time declared by a RFN expires, the RFN will broadcast the ring termination message to its RMNs with Radio-II. The RMNs receiving this message certainly become DNs.

### B. Emergency Message Exchange Protocol

Emergency messages are the most important information in IVC which should be broadcast to vehicles in the system as fast and reliable as possible. When a RMN detects an accident, it will quickly report this to its RFN with Radio-II during the  $T_s$  period. Then the RFN will broadcast the emergency message to all nearby nodes using both Radio-I (inter-ring notification) and Radio-II (intra-ring notification) during the same  $T_s$  period. Therefore, the delivery of emergency messages takes four main steps: i) a RMN detects an accident and transmits an emergency message to its RFN by adopting CSMA/CA on Radio-II during the  $T_s$  interval; ii) upon receiving the emergency message from Radio-II, the RFN will reply an acknowledgement to the RMN, and then broadcast the emergency message to all its RMNs with Radio-II; iii) at the same time, the RFN broadcasts the emergency message to its neighboring DNs, SDNs, RFNs with Radio-I; iv) neighboring RFNs rebroadcast the emergency message with Radio-I by adopting simple flooding [17] for multi-hop emergency message relaying. They also broadcast the emergency message to their RMNs with Radio-II in the meantime. It is possible that two nodes in the same ring detect the same accident simultaneously and both will deliver emergency messages to their RFN, which may cause packet collisions. However, by applying efficient ring management along with adaptive channel scheduling described in IV-A, the contention level within a ring or in each SCH during the  $T_s$  period is very low and negligible. Our simulation results show that contention based CSMA/CA can provide efficient message delivery under low traffic and contention levels, which is confirmed by the results shown in [18]. Therefore, the emergency message delivery performance can be guaranteed by adopting the multi-channel ring structure.

### C. Data Exchange Protocol

When a node receives the data from the upper layer, it first checks whether the next hop node is in the same ring or not based on the local ring information. The node uses Radio-I and Radio-II for inter-ring and intra-ring data communications, respectively. In MCTRP, a RMN has two data buffers, e.g., intra-ring data buffer (IADB) which stores packets to be transmitted to RMNs in the same ring and inter-ring data buffer (IRDB) which stores packets to be delivered to the nearby DNs, SDNs, and RMNs in different rings. Inter-ring data packets are transmitted with CSMA/CA mechanism, and in the following sections, we focus on efficient token based intra-ring data communications.

We propose a token based data exchange protocol for efficient intra-ring data communications. The maximum token holding time of each node is denoted by  $T_{MTH}$ . When a node receives a token from its predecessor, it first checks its IADB. If the buffer is non-empty during the  $T_{MTH}$ , the THN starts data transmissions, and passes the token to its successor when  $T_{MTH}$  is reached. To ensure token delivery, the THN will retransmit the token if no acknowledgement (ACK) is received before the token retransmission timer is timeout. If the maximum retry limit  $T_{retry}$  is reached, the THN will report to the RFN that its current successor is not reachable (the successor is in deep fading for a long time or has left the ring due to mobility), and the RFN will delete the successor from the ring and update the ring information in the next  $T_c$ , as described in Sec. IV-A. The THN then attempts to connect to the next node since all nodes in the ring have the ring topology information. After successfully passing the token to the next node, the THN switches to the RMN status. If the IADB of the THN is empty during  $T_{MTH}$ , the THN will start a timer and keep checking the buffer status. The THN will pass the token to its successor if no data arrives before the timer expires. This is to ensure the following nodes with intra-ring data packets can acquire the token as soon as possible. The pseudo code of the token based data exchange is presented in Algorithm 1. Note that the token is delivered by broadcasting, and the RFN will keep record of each token passing process. If the RFN can not receive any broadcast token for a fixed time interval, which implies the token has been lost, it will generate a new token.

## V. PERFORMANCE ANALYSIS

In this section, we develop an analytical model to study the performance of the proposed MCTRP, in terms of the time for a ring having its  $N_{max}$  RMNs, the average delay of emergency message delivery, the average throughput of intra-ring communications, and the delay for a RMN receiving the token. We consider a network consisting of multiple rings and enough DNs to join different rings. Inter-ring data communications are based on CSMA/CA mechanism with RTS/CTS control frames since data packets are usually larger than the RTS threshold.

### A. Full Ring Delay

A ring is said to be *full* if it has its maximum number of RMNs. The time for a ring to be *full* is thus called the *full* ring delay. It is used to evaluate the efficiency of the distributed ring coordination among multiple nodes. For a given number of vehicles, a less number of rings are formed with more members in each ring, which is desirable for contention based inter-ring communications due to the reduced contentions among rings. Moreover, more rings not only increase the potential collisions among inter-ring nodes, but also require more SCHs and thus may increase the inter-ring co-channel interference. On the other hand, if more DNs can quickly join rings, a fewer number of DNs would need to contend for channel access with Radio-I operating on CH178, which is favorable for inter-ring communications.

### Algorithm 1 Token Delivery Algorithm

```

1: if A node  $i$  received a token then
2:    $t_{th} = 0$ ;
3:   if  $i.IADB \neq NULL$  then
4:     If the timer  $t_w$  is open, turn off it;
5:     Get a packet D from  $i.IADB$ , and compute its transmission
      time  $t_d$ ;
6:     if  $t + t_d \leq T$  then
7:       if  $t_{th} + t_d \leq T_{MTH}$  then
8:         Transmit data;
9:         Update the current time  $t = t + t_d$  and token hold time
       $t_{th} = t_{th} + t_d$ ;
10:      if transmission is successful then
11:        Delete D from  $i.IADB$ , and go to line 3;
12:      else
13:        Go to line 6;
14:      end if
15:    else
16:      Go to line 31;
17:    end if
18:  else
19:    Wait until next data exchange period  $T_D$  and go to line 6;
20:  end if
21: else
22: if the timer  $t_w$  is off then
23:   Turn on the timer  $t_w$ ;
24: end if
25: if the value of  $t_w$  is less than  $\eta$  then
26:   Keep checking buffer status, and go to line 3 when
       $i.IADB$  becomes non-empty;
27: else
28:   Go to line 31;
29: end if
30: end if
31: Set  $t_{retry} = 0$ ;
32: if  $t_{retry} \leq T_{retry}$  then
33:   if  $t + t_{token} \leq T$  then
34:     Attempt to pass the token to the successor;
35:     Update  $t = t + t_{token}$  and  $t_{retry} ++$ ;
36:   else
37:     Wait until next data exchange period  $T_D$  to pass a token;
38:   end if
39:   if Token passing is successful then
40:     Successor receives a token, go to line 1
41:   else
42:     Go to line 32;
43:   end if
44: else
45:   Attempt to pass the token to the next node of  $i$ 's successor
      and go to line 31.
46: end if
47: end if

```

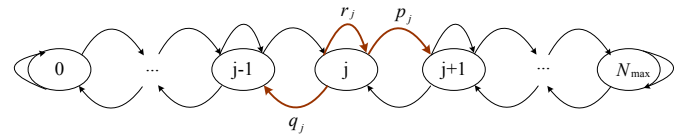

Fig. 6. State transition of a ring modeled by Markov chain.

To obtain the *full* ring delay, we capture the dynamic change of the number of vehicles in a ring using a discrete-time Markov chain on state space  $\{0, 1, 2, \dots, N_{max}\}$ , where each state variable  $X_i$   $\{i = 0, 1, 2, \dots\}$  represents the number of vehicles in a ring at step  $i$ , as shown in Fig. 6. The one-step transition probability of the Markov chain can be obtained as

follows. The probability  $p_j$  represents the joint probability that a DN joins the ring successfully and none of the RMNs leaves the ring, given there are  $j$  RMNs in the ring. Let  $\mathbf{E}_j$  denote the event that a DN joins a ring successfully, and  $\mathbf{E}_l$  denote the event that one of RMNs leaves its ring successfully, then  $p_j = Pr[\mathbf{E}_j \cap \overline{\mathbf{E}}_l]$ .  $Pr[\mathbf{E}_j] = p_{jr1} \cdot p_{jr2}$ , is the joint probability that a DN transmits a JAM and receives a CNM successfully denoted as  $p_{jr1}$ , and the SDN (the DN becomes a SDN) connects to its successor and transmits a JSM successfully denoted by  $p_{jr2}$ . Similarly,  $Pr[\overline{\mathbf{E}}_l] = (1 - p_{lr1} \cdot p_{lr2})^j$ , where  $p_{lr1}$  is the probability a RMN leaves a ring, and  $p_{lr2}$  is the probability that it is deleted successfully. Therefore,  $p_j$  is expressed as

$$p_j = p_{jr1} p_{jr2} (1 - p_{lr1} p_{lr2})^j. \quad (1)$$

Using the similar argument, the probability  $q_j$  which denotes the joint probability that one of RMNs leaves the ring successfully and no DN joins into the ring successfully is given as

$$q_j = \binom{j}{1} p_{lr1} p_{lr2} (1 - p_{lr1} p_{lr2})^{j-1} (1 - p_{jr1} p_{jr2}). \quad (2)$$

Finally,  $r_j$  denotes the joint probability that no DN joins the ring and no RMN leaves the ring, and can be obtained according to

$$\begin{cases} p_0 + r_0 = 1, \\ q_{N_{\max}} + r_{N_{\max}} = 1, \\ p_j + r_j + q_j = 1, \quad j \in [1, N_{\max} - 1]. \end{cases} \quad (3)$$

Transition probability matrix of the Markov chain is given as

$$\mathbf{P} = \begin{bmatrix} r_0 & p_0 & 0 & \cdots & 0 & 0 & 0 \\ q_1 & r_1 & p_1 & \cdots & 0 & 0 & 0 \\ \vdots & \vdots & \vdots & \vdots & \vdots & \vdots & \vdots \\ 0 & 0 & 0 & \cdots & q_{N_{\max}-1} & r_{N_{\max}-1} & p_{N_{\max}-1} \\ 0 & 0 & 0 & \cdots & 0 & q_{N_{\max}} & r_{N_{\max}} \end{bmatrix}. \quad (4)$$

Let  $M = \min_k(X_k = N_{\max})$  denote the minimum number of steps for a ring to be *full* from the current state  $j$  at step 0.  $e_j = E[M|X_0 = j]$  denotes the average value of  $M$ , and it can be expressed as

$$e_j = E[M|X_0 = j] = \sum_{k=0}^{\infty} k \cdot Pr[X_k = N_{\max}|X_0 = j] \quad (5-A)$$

$$= \sum_{k=0}^{\infty} k \sum_{l=j-1}^{j+1} Pr[X_k = N_{\max}|X_0 = j, X_1 = l] \cdot Pr[X_1 = l|X_0 = j] \quad (5-B)$$

$$= \sum_{k=0}^{\infty} k \sum_{l=j-1}^{j+1} Pr[X_k = N_{\max}|X_1 = l] \cdot Pr[X_1 = l|X_0 = j] \quad (5-C)$$

$$= q_j \cdot E[M|X_1 = j-1] + r_j \cdot E[M|X_1 = j] + p_j \cdot E[M|X_1 = j+1] \quad (5-D)$$

$$= q_j(E[M|X_0 = j-1] + 1) + r_j(E[M|X_0 = j] + 1) + p_j(E[M|X_0 = j+1] + 1) \quad (5-E)$$

$$= q_j \cdot e_{j-1} + r_j \cdot e_j + p_j \cdot e_{j+1} + 1, \quad 0 < j < N_{\max}. \quad (5)$$

By applying the law of total probability, we obtain (5-B). Due to the Markovian property, (5-B) can be re-written as (5-C). Conditioned on the first state  $X_1 = j$ , the average number of steps for the ring to be *full*,  $E[M|X_1 = j] = E[M|X_0 = j] + 1$ , where  $E[M|X_0 = j]$  is the average number of steps for the ring to be *full* starting from the initial state  $X_0 = j$ . Similarly, we have  $E[M|X_1 = j-1] = E[M|X_0 = j-1] + 1$  and  $E[M|X_1 = j+1] = E[M|X_0 = j+1] + 1$ , and we can obtain (5-E). Therefore,  $e_j$  can be expressed as

$$e_j = \frac{q_j \cdot e_{j-1} + p_j \cdot e_{j+1} + 1}{p_j + q_j}, \quad 0 < j < N_{\max}. \quad (6)$$

$e_{N_{\max}} = E[M|X_0 = N_{\max}]$  represents that there are already  $N_{\max}$  nodes in the ring at step 0, and therefore  $e_{N_{\max}} = 0$ . Furthermore,  $X_0 = 0$  means the ring does not exist at step 0, thus  $Pr[X_M = N_{\max}|X_0 = 0] = 0$ , and  $e_0 = E[M|X_0 = 0] = 0$ . We then have

$$e_{j-1} = \begin{cases} 0 & j = 1, \\ (1 + \frac{p_j}{q_j})e_j - \frac{p_j}{q_j}e_{j+1} - \frac{1}{q_j} & 1 < j < N_{\max}, \\ 0, & j = N_{\max} + 1, \end{cases} \quad (7)$$

which gives

$$e_{N_{\max}-2} = \left(1 + \frac{p_{N_{\max}-1}}{q_{N_{\max}-1}}\right)e_{N_{\max}-1} - \frac{1}{q_{N_{\max}-1}} \quad (8)$$

Based on Eq. (7) and Eq. (8), we can obtain  $e_j$  as

$$e_j = \left(1 + \sum_{k=j+1}^{N_{\max}-1} \prod_{m=j+1}^k \frac{p_m}{q_m}\right) \cdot \frac{\sum_{k=1}^{N_{\max}-1} \frac{1}{q_k} (1 + \sum_{n=1}^{k-1} \prod_{m=1}^n \frac{p_{k-m+1}}{q_{k-m}})}{1 + \sum_{k=1}^{N_{\max}-1} \prod_{m=1}^k \frac{p_m}{q_m}} - \sum_{k=j+1}^{N_{\max}-1} \frac{1}{q_k} \left(1 + \sum_{n=1}^{k-1} \prod_{m=1}^n \frac{p_{k-m+1}}{q_{k-m}}\right), \quad 0 < j < N_{\max}, \quad (9)$$

## B. Average Emergency Message Delay

The emergency message generated by a RMN takes four steps to reach other nodes: (1) an emergency message is delivered to its RFN during the period  $T_s$ ; (2) the RFN then broadcasts the emergency message to all its RMNs; (3) through contentions, the RFN wins the opportunity to broadcast the emergency message to its neighboring DNs and other RFNs; (4) a RFN that receives the emergency message broadcasts it to its RMNs. Therefore, the delay of an emergency message is dependent on node types. For RMNs in the same ring, they only need to go through the steps (1) and (2) to receive the emergency message. DNs and SDNs would take steps (1) and (3) to receive the emergency message, while other RMNs in different rings receive the emergency message through steps (1), (3) and (4).

Let  $T_{xy}$  denote the delay of the emergency message transmitted from a RMN  $x$  to a node  $y$ , and  $I(x)$  is the RFN of node  $x$ . If  $y$  is a DN or SDN,  $I(y) = \emptyset$ . When a RMN  $x$  transmits an emergency message, the emergency message delay is given by

$$T_{xy} = \begin{cases} t_s + t_r & \text{if } I(x) = I(y), \\ t_s + t_m & \text{if } I(y) = \emptyset, \\ t_s + t_m + t_r & \text{if } I(y) \neq \emptyset \text{ and } I(x) \neq I(y), \end{cases} \quad (10)$$

where  $t_s$  is the time for transmitting an emergency message

from a RMN to its RFN,  $t_r$  is the time spent by the RFN broadcasting an emergency message to its RMNs, and  $t_m$  is the duration that the RFN broadcasts an emergency message to its neighboring RFNs, DN and SDNs. It is possible that two nodes in the same ring detect an accident, and deliver emergency messages to their RFN simultaneously. However, the number of RMNs in each ring can not be larger than  $N_{max}$ , and moreover the collision probability of intra-ring emergency message exchange is very little. Consequently, the contentions in steps (1), (2) and (4) are negligible, and the corresponding time spent in these steps are bounded. Therefore, a RMN only waits for a  $t_{sifs}$  before accessing the channel in the  $T_s$  interval and there is no contention for the transmission in the same ring, and  $t_s = 2t_{sifs} + L_{em}/R_b + t_{ack}$ ,  $t_r = t_{sifs} + L_{em}/R_b$ , where  $L_{em}$  is the packet size of the emergency message. In the following, we focus on the emergency message broadcasting in step (3), which is transmitted in contention mode on CH178. For a node  $i$ , we further define  $F_i$  as the set of the neighboring RFNs within its transmission range,  $D_i$  is the set of DN and SDNs operating on the same channel within its transmission range,  $N_i$  is the set of RMNs in the same ring with node  $i$ , and  $|F_i|$ ,  $|D_i|$ ,  $|N_i|$  are the numbers of nodes in  $F_i$ ,  $D_i$ ,  $N_i$  respectively. We define  $\gamma_i$  as the probability that a node  $i$  randomly selects a time slot, and  $\theta_i$  is the probability that at least one neighboring node selects the same time slot. From [19]:

$$\gamma_i = \frac{2(1 - 2\theta_i)}{(1 - 2\theta_i)(cw_{min} + 1) + \theta_i cw_{min}(1 - 2\theta_i^{T_{retry}})}, \quad (11)$$

$$\theta_i = 1 - (1 - \gamma_i)^{|F_i| + |D_i|}, \quad (12)$$

where  $cw_{min}$  is the minimum contention window size, and  $T_{retry}$  is the maximum retry limit. Let  $\tau_i$  denote the probability that no other nodes choose the same time slot, and node  $i$  transmits a packet successfully, consequently it can be represented as:

$$\tau_i = \frac{\gamma_i(1 - \gamma_i)^{|F_i| + |D_i|}}{\theta_i + \gamma_i(1 - \gamma_i)^{|F_i| + |D_i|}}. \quad (13)$$

Let  $Z$  denote the number of neighboring nodes that send their packets successfully during the backoff period of node  $i$ . Assuming equal transmission probability of each node, the mean of  $Z$  can be obtained as  $E(Z) = (|F_i| + |D_i|) \cdot \tau_i$ . Each data transmission will occupy the channel for the interval  $t_p$ , which is given by

$$t_p = t_{difs} + t_{rts} + 4\varphi + 3t_{sifs} + t_{cts} + L_d/R_d + t_{ack}, \quad (14)$$

where  $t_{difs}$  is the DIFS interval,  $t_{rts}$ ,  $t_{cts}$  and  $t_{ack}$  are the time for transmitting a RTS, a CTS and an ACK packet, respectively,  $\varphi$  is the propagation delay.  $L_d$  is the size of a data packet,  $R_d$  is the data transmission rate. Accordingly, the delay  $t_b$  which includes the frozen time due to neighboring nodes' transmissions and the backoff time can be given by  $t_b = E[Z] \cdot t_p + E[CW] \cdot \rho$ , where  $E[CW]$  is the average contention window size, and  $\rho$  is the slot duration.  $t_m$  is the sum of  $t_{difs}$ , the delay  $t_b$ , and the emergency message transmission time, which is denoted as  $t_m = t_{difs} + t_b + L_{em}/R_b$ .

### C. Average Ring Throughput

Since a node can transmit its intra-ring data packets only when it holds a token in the  $T_d$  interval, the ring throughput depends on how long a node holds the token. A THN is in *saturated* state if it always has data packets in its IADB to transmit during the  $T_{MTH}$  interval, and being in *unsaturated* state if it holds the token only for partial  $T_{MTH}$  interval. Let  $\phi_d$  and  $\phi_t$  denote the transmission time of the data and the token, respectively, which are given by

$$\phi_d = t_{sifs} + L_d/R_d + \varphi + t_{sifs} + t_{ack} + \varphi \quad (15)$$

$$\phi_t = t_{sifs} + L_T/R_b + \varphi + t_{sifs} + t_{ack} + \varphi \quad (16)$$

The average throughput  $S$  during the period  $T$  can be obtained as

$$S = \frac{|\mathbf{N}_f| \cdot \frac{T_{MTH} - \phi_t}{\phi_d} \cdot L_D + \sum_{i \in \overrightarrow{\mathbf{N}_f}} n_i \cdot L_D}{T}, \quad (17)$$

where  $n_i$  is number of packets that an *un-saturated* node  $i$  transmits within its token holding time,  $\mathbf{N}_f$  is the set of *saturated* nodes during the period  $T$ ,  $\overrightarrow{\mathbf{N}_f}$  is the set of *un-saturated* nodes during the period  $T$ .  $|\mathbf{N}_f|$  is the number of nodes in  $\mathbf{N}_f$ . A special case arises when all RMNs are in *saturated* state, leading to the average ring throughput:

$$S = |\mathbf{N}_f| \cdot (T_{MTH} - \phi_t) \cdot L_D / (T \cdot \phi_d). \quad (18)$$

### D. Access Delay

The access delay measures how long a RMN needs to wait from the THN to obtain the token for intra-ring data communications. We denote  $n_{ij}$  as the number of total nodes from the current THN  $i$  to another RMN  $j$  in the token circulation direction. There will be  $n_{ij} \cdot |\mathbf{N}_f| / (|\mathbf{N}_f| + |\overrightarrow{\mathbf{N}_f}|)$  *saturated* nodes from  $i$  to  $j$ . If nodes  $i$  and  $j$  are in the same  $T_d$  period, node  $j$  will not wait  $T_s$  and  $T_c$  interval, and the waiting time  $t_{ij}$  which represents the latency for node  $j$  obtaining the token from  $i$  is given as  $t_{ij} = n_{ij} \cdot |\mathbf{N}_f| / (|\mathbf{N}_f| + |\overrightarrow{\mathbf{N}_f}|) \cdot T_{MTH} + \sum_{i \in \overrightarrow{\mathbf{N}_f}} (n_i \cdot \phi_d + \eta + \phi_t)$ , where  $\eta$  is the value set by token passing timer, meaning that an *un-saturated* state node must pass the token to its successor if there are no packets in IADB to transmit for a period of  $\eta$ . If nodes  $i$  and  $j$  are in successive  $T_d$  period, the access delay is expressed as  $t_{ij} = T_s + T_c + n_{ij} \cdot |\mathbf{N}_f| / (|\mathbf{N}_f| + |\overrightarrow{\mathbf{N}_f}|) \cdot T_{MTH} + \sum_{i \in \overrightarrow{\mathbf{N}_f}} (n_i \cdot \phi_d + \eta + \phi_t)$ .

## VI. NUMERICAL RESULTS

Extensive simulations are conducted with ns-2 [20] to evaluate the performance of MCTRP. We consider the scenario where vehicles are running on a 10m width highway, and they move at the speed between 10m/s and 30m/s to the same direction. All the vehicles are randomly distributed and within each other's transmission range at the beginning. To the best of our knowledge, how to model wireless fading channel in VANET is still an open issue. In this paper, we use the wireless channel model in NS-2, where Friis free-space model for short distance and the two-ray model for long distance are used to determine the received power, and no pass loss due to shadowing is considered. We repeat every simulation for 100 times, each of which takes 50 seconds, and calculate

TABLE II  
PARAMETERS USED IN PERFORMANCE EVALUATION

Parameter	Value	Parameter	Value
$t_{sifs}$	32 $\mu$ s	$T_{retry}$	5
$t_{difs}$	64 $\mu$ s	RTS	21 bytes
$\rho$	16 $\mu$ s	CTS	15 bytes
$\varphi$	1 $\mu$ s	ACK	15 bytes
$cw_{min}$	31	RFM	22 bytes
$cw_{max}$	1023	JIM	29 bytes
$T$	60 ms	JAM	21 bytes
$T_s$	20 ms	CNM	23 bytes
$T_c$	10 ms	CSM	21 bytes
$T_d$	30 ms	JSM	22 bytes
$T_{MTH}$	5 ms	$L_d$	512 bytes
$v_d$	5 m/s	$L_{em}$	100 bytes
$N_{max}$	10	transmission range	250m
basic rate ( $R_b$ )	1 Mbps	data rate ( $R_d$ )	11 Mbps

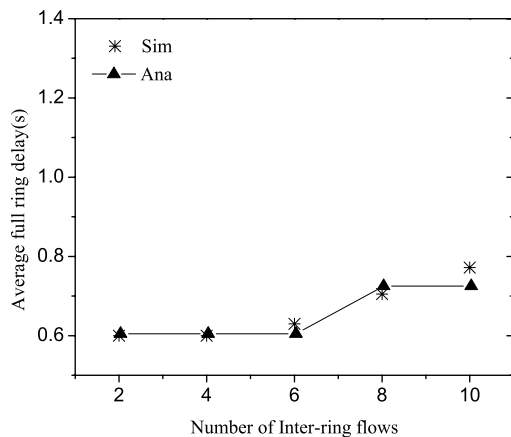

Fig. 7. Average full ring delay vs. number of inter-ring flows.

the average value. The parameters used in the simulations are listed in Table II.

*Average full ring delay* – Fig. 7 shows the average full ring delay versus the number of inter-ring flows in the network. As mentioned in Sec. V-A, it is desirable that DNs should be quickly organized into rings. It can be observed that average full ring delay increases as the number of inter-ring flows increases, which takes 0.6 ~ 0.8 s, for 2 to 10 flows at the constant bit rate (CBR) of 100 packets/s. Since we bound the speed difference between RMNs and their RFNs to  $[0, v_d]$ , the topology of the ring is relatively stable, and a ring can quickly reach full state after it is created given a sufficient number of DNs. However, with the number of inter-ring flows increasing, JAMs and CNMs may be lost due to collisions, which makes the joining process aborted.

*Average emergency message delay* – In MCTRP, the RFN contends for channel access with neighboring inter-ring flows in order to broadcast the emergency message to neighboring RFNs, DNs. Inter-ring flows in this simulation are transmitted at the rate of 100 packets/s. Fig. 8(a) shows the average emergency message delay under different numbers of inter-ring flows in both inter-ring and intra-ring communications. It can be seen that even for the high node density, e.g., 10

flows, the emergency message delays in both inter-ring and intra-ring communications are less than 20ms, which is much less than the common accepted requirement (100ms) for safety applications in VANET [21]. Furthermore, the delay of intra-ring is always less than that of inter-ring, and is independent of the number of inter-ring flows. This is because the emergency message exchange within a ring takes place on the dedicated SCH during the  $T_s$  interval when only a limited number of nodes contend in the ring, and consequently the delay is not sensitive to the increase of the number of inter-ring flows in the network. While inter-ring emergency messages are delivered by the RFN contending with a number of DNs, SDNs, RFNs on the channel CCH178. This is an important advantage of MCTRP over the purely use of contention-based MAC protocols in vehicular communications, as intra-ring nodes close to the accident site have a higher chance to quickly receive the warning message.

*Average ring throughput* – The throughput of MCTRP, IEEE 802.11, and OTRP [13] are compared, as shown in Fig. 8. All nodes are within each other's transmission range, and a RMN starts intra-ring data exchange after it receives the token. We consider different traffic load by varying the CBR rate. Fig. 8(b) shows the number of data flows versus the throughput of MCTRP, IEEE 802.11, and OTRP with nodes in saturated scenario, which means all the transmitters always have data packets to send in their buffers. As the number of flows increases, the throughput of IEEE 802.11 decreases greatly, while the throughput of MCTRP and OTRP do not vary much, and are higher than that of IEEE 802.11 eventually. However, the throughput of OTRP is much lower than that of MCTRP all the time. These observations can be explained as follows. In IEEE 802.11, packet collisions are serious in dense nodes scenario, which degrades the channel utilization. OTRP can reduce collisions by incorporating nodes into different rings. But it can not eliminate collisions among different rings. In MCTRP, the token holding time for a saturated THN consists of two parts: 1) the data transmission time; and 2) the token exchange time. There are no RTS/CTS control packets for intra-ring data communications, which boosts the utilization of channel resource dramatically and thus increases the throughput. Furthermore, taking the advantage of multi-channel structure in MCTRP, different rings set up in dense node scenario, and adopt different SCHs. As a result, the whole network throughput will increase since there are no co-channel interference within the transmission range.

Fig. 8(c) shows the throughput comparison among MCTRP, IEEE 802.11, and OTRP with nodes in unsaturated state. It is observed that IEEE 802.11 performs better than MCTRP and OTRP for a small number of flows. With the node density increasing, the throughput of IEEE 802.11 decreases significantly as compared to that of MCTRP and OTRP. Similar to throughput comparison in saturated state, throughput of OTRP is much lower than that of MCTRP. MCTRP makes use of the multi-channel structure in conjunction with the token for intra-ring communications, which significantly reduce the contentions among neighboring nodes, and consequently the ring throughput of MCTRP does not change much as the node density increases, which makes it suitable for the VANET with a dense vehicle network. Even packet collision in light traffic

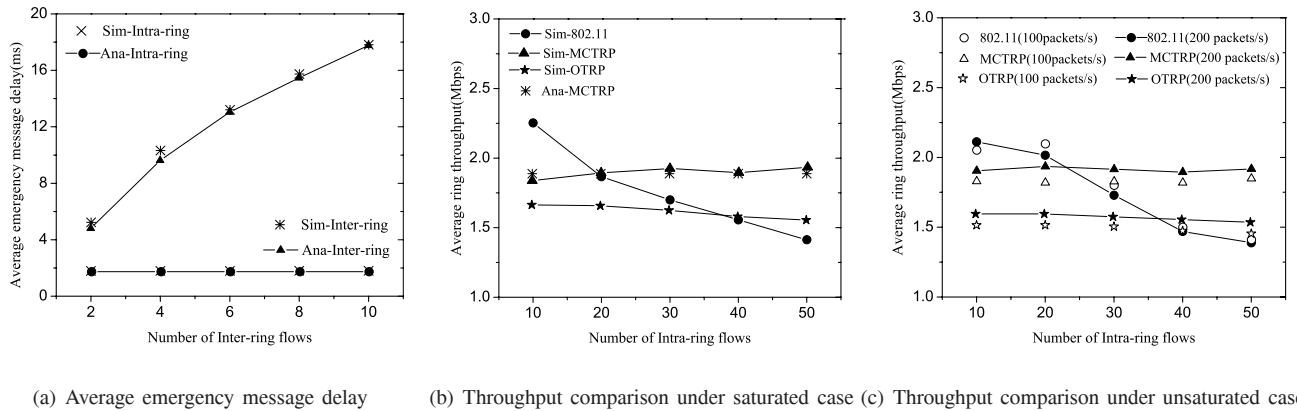

Fig. 8. Average full ring delay of MCTRP as well as throughput comparisons between MCTRP and IEEE 802.11

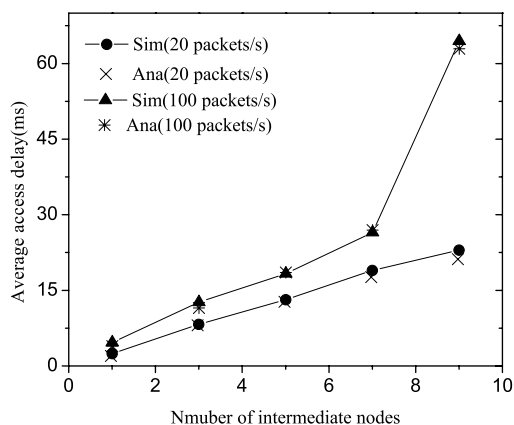

Fig. 9. Access delay for RMNs.

load is not extensive, OTRP may not fully utilize the channel because each node is required to hold the token for a constant period of time without adapting to the dynamic change of traffic load.

*Access delay* – Fig. 9 shows the access delay for a RMN  $j$  to receive the token from the current THN  $i$ . Firstly, we can observe that the access delay increases with a larger number of intermediate nodes between  $j$  and  $i$ . Moreover, the access delay increases sharply when the number increases from 7 to 9 with traffic load 100 packets/s. It is because that  $j$  can not receive the token at the end of  $T_d$ , and it must wait  $T_s + T_c$  time interval for next  $T_d$ . Secondly, the traffic load also has a direct impact on the access delay. For a fixed number of intermediate nodes,  $j$  takes much longer time to receive the token when the traffic load of intermediate nodes is higher, and the maximum access delay is reached when all intermediate nodes are *saturated*. In MCTRP, the token holding time varies according to the node's traffic load. If there is no packet in IADB for a time interval set by the token passing timer, the THN must deliver the token to its successor. It prevents a node which has no data packets to transmit from holding the token for the whole  $T_{MTH}$  interval, while a node with a heavy traffic load has to wait the token for intra-ring data communications.

## VII. CONCLUSION

We have proposed a multi-channel token ring protocol for achieving efficient inter-vehicle communications based on the channel structure specified in IEEE 802.11p. By combining the notion of virtual rings and distributed multi-channel management, the proposed protocol has the following features: i) The emergency messages can quickly be delivered to nearby vehicles; ii) The network throughput is significantly improved especially in dense vehicle scenarios by dynamic SCHs allocation; and iii) MCTRP reduces the channel access time of each node by adjusting the token holding time of nodes according to their traffic load. In addition, an analytical model has been developed to evaluate the performance of MCTRP, and simulation results have been given to demonstrate that MCTRP can guarantee QoS requirements for both safety related applications and non-safety multimedia applications in IVC. In our future work, we will extend MCTRP to integrate RVC and IVC communications environment. We will further study the performance of proposed protocol in the presence of different fading and shadowing scenarios in VANET.

## REFERENCES

- [1] S. Biswas, R. Tatchikou, and F. Dion, "Vehicle-to-vehicle wireless communication protocols for enhancing highway traffic safety," *IEEE Commun. Mag.*, vol. 44, no. 1, pp. 74-82, Jan. 2006.
- [2] J. Luo and J. P. Hubaux, "A survey of inter-vehicular communication," Technical Report IC/2004/24, School of Computer and Communication Sciences, PFL, 2004.
- [3] T. Hasegawa, K. Mizui, H. Fuji, and K. Seki, "A concept reference model for inter-vehicle communications (Report 2)," in *Proc. IEEE ITSC'04*, pp. 810-815, Oct. 2004.
- [4] Y. G. Bi, K. H. Liu, X. Shen, H. Zhao, "A multi-channel token ring protocol for inter-vehicle communications," in *Proc. IEEE GLOBE-COM'08*, pp. 1-5, Nov. 2008.
- [5] D. Lee, R. Attias, A. Puri, R. Sengupta, S. Tripakis, and P. Varaiya, "A wireless token ring protocol for intelligent transportation systems," in *Proc. IEEE ITSC'01*, pp. 1152-1157, Aug. 2001.
- [6] P. Varaiya, "Smart cars on smart roads: problems of control," *IEEE Trans. Aut. Control*, vol. 38, no. 2, pp. 195-207, Feb. 1993.
- [7] IEEE 802.11p, *Wireless Access in Vehicular Environments (WAVE)*, draft standard, IEEE Computer Society, 2006.
- [8] Y. P. Zang, L. Stibor, B. Walke, H. J. Reumerman, and A. Barroso, "Towards broadband vehicular ad-hoc networks - the Vehicular Mesh Network (VMESH) MAC Protocol," in *Proc. IEEE WCNC'07*, pp. 417-422, Mar. 2007.
- [9] H. Su and X. Zhang, "Clustering-based multi-channel MAC protocols for QoS provisionings over vehicular ad-hoc networks," *IEEE Trans. Veh. Technol.*, vol. 56, no. 6, pp. 3309-3323, Nov. 2007.

- [10] S. Wu, C. Lin, Y. Tseng, and J. Sheu, "A new multi-channel MAC protocol with on-demand channel assignment for multi-hop mobile ad hoc networks," in *Proc. ISPAN'00*, pp. 232-237, Dec. 2000.
- [11] L. Cai, X. Shen, J. W. Mark, and J. Pan, "QoS Support for Multimedia Traffic in Wireless/Wired Networks using TCP-friendly AIMD Protocols," *IEEE Trans. Wireless Commun.*, vol. 5, no. 2, pp. 469-480, Feb. 2006.
- [12] P. Wang and W. Zhuang, "A token-based scheduling scheme for WLANs supporting voice/data traffic and its performance analysis," *IEEE Trans. Wireless Commun.*, vol. 7, no. 4, pp. 1708-1718, Apr. 2008.
- [13] J. Zhang, K.-H. Liu, and X. Shen, "A novel overlay token ring protocol for inter-vehicle communication," in *Proc. IEEE ICC'08*, pp. 4904-4909, May 2008.
- [14] J. Peng and L. Cheng, "A distributed MAC scheme for emergency message dissemination in vehicular ad-hoc networks," *IEEE Trans. Veh. Technol.*, vol. 56, no. 6, pp. 3300-3308, Nov. 2007.
- [15] F. Yu and S. Biswas, "Self-configuring TDMA protocols for enhancing vehicle safety with DSRC based vehicle-to-vehicle communications," *IEEE J. Select. Areas Commun.*, vol. 25, no. 8, pp. 1526-1537, Oct. 2007.
- [16] M. Torrent-Moreno, "Inter-vehicle communications: assessing information dissemination under safety constraints," in *Proc. IEEE/IFIP WONS*, pp. 59-64, Jan. 2007.
- [17] C. Ho, K. Obraczka, G. Tsudik, and K. Viswanath, "Flooding for reliable multicast in multi-hop ad-hoc networks," in *Proc. DIALM*, pp. 64-71, Aug. 1999.
- [18] L. X. Cai, X. Shen, J. W. Mark, L. Cai, and Y. Xiao, "Voice capacity analysis of WLAN with unbalanced traffic," *IEEE Trans. Veh. Technol.*, vol. 55, no. 3, pp. 752-761, May 2006.
- [19] G. Bianchi, "Performance analysis of the IEEE 802.11 distributed coordination function," *IEEE J. Select. Areas Commun.*, vol. 18, no. 3, pp. 535-547, Mar. 2000.
- [20] The Network Simulator ns-2, <http://www.isi.edu/nsnam/ns>.
- [21] S. Eichler, "Performance evaluation of the IEEE 802.11p WAVE communication standard," in *Proc. IEEE VTC'07*, pp. 2199-2203, Sept. 2007.



**Yuanguo Bi** received the B.Sc. degree in Liaoning University, Shenyang, China in 2003 and M.Sc. degree in Northeastern University, Shenyang, China in 2006, both in computer science. He is pursuing the Ph.D. degree at Northeastern University, Shenyang, China, and is a visiting Phd student with Department of Electrical and Computer Engineering, University of Waterloo, ON, Canada. His current research interests focus on resource allocation, QoS routing, and broadcast control in multihop vehicular ad hoc network.



**Kuang-Hao Liu** (M08) received the B.S. degree in applied mathematics from National Chiao Tung University, Hsinchu, Taiwan, in 1998 and the M.S. degree in electrical engineering from National Chun Hsing University, Taichung, Taiwan, in 2000. From 2000 to 2002, he was a Software Engineer with Siemens Telecommunications System Ltd., Taiwan. Since August 2008, he has been with the Department of Electrical Engineering, National Cheng Kung University, Tainan, Taiwan, as an assistant professor. His research interests include UWB communications

in personal area networks, resource-allocation problems in wireless networks, and performance analysis for communication protocols.

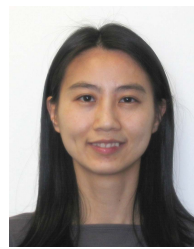

**Lin X. Cai** received the B.Sc. degree in computer science from Nanjing University of Science and Technology, Nanjing, China, in 1996 and the M.A.Sc. degree in electrical and computer engineering from the University of Waterloo, Waterloo, Canada, in 2005. She is currently working toward a Ph.D. degree in the same field at the University of Waterloo. Her research interests include network performance analysis and protocol design for multimedia applications over broadband wireless networks.



**Xuemin (Sherman) Shen** (M'97-SM'02-F'09) received the B.Sc. (1982) degree from Dalian Maritime University (China) and the M.Sc. (1987) and Ph.D. degrees (1990) from Rutgers University, New Jersey (USA), all in electrical engineering. He is a Professor and University Research Chair, Department of Electrical and Computer Engineering, University of Waterloo, Canada. Dr. Shen's research focuses on mobility and resource management in inter-connected wireless/wired networks, UWB wireless communications networks, wireless network security,

wireless body area networks, vehicular ad hoc and sensor networks. He is a co-author of three books, and has published more than 400 papers and book chapters in wireless communications and networks, control and filtering. Dr. Shen served as the Tutorial Chair for IEEE ICC'08, the Technical Program Committee Chair for IEEE Globecom'07, the General Co-Chair for Chinacom'07 and QShine'06, the Founding Chair for IEEE Communications Society Technical Committee on P2P Communications and Networking. He also serves as a Founding Area Editor for IEEE TRANSACTIONS ON WIRELESS COMMUNICATIONS; Editor-in-Chief for PEER-TO-PEER NETWORKING AND APPLICATION; Associate Editor for IEEE TRANSACTIONS ON VEHICULAR TECHNOLOGY; KICS/IEEE JOURNAL OF COMMUNICATIONS AND NETWORKS, COMPUTER NETWORKS; ACM/WIRELESS NETWORKS; and WIRELESS COMMUNICATIONS AND MOBILE COMPUTING (Wiley), etc. He has also served as Guest Editor for IEEE JSAC, IEEE WIRELESS COMMUNICATIONS, IEEE COMMUNICATIONS MAGAZINE, and ACM MOBILE NETWORKS AND APPLICATIONS, etc. Dr. Shen received the Excellent Graduate Supervision Award in 2006, and the Outstanding Performance Award in 2004 and 2008 from the University of Waterloo, the Premier's Research Excellence Award (PREA) in 2003 from the Province of Ontario, Canada, and the Distinguished Performance Award in 2002 and 2007 from the Faculty of Engineering, University of Waterloo. Dr. Shen is a registered Professional Engineer of Ontario, Canada, and a Distinguished Lecturer of IEEE Communications Society.



**Hai Zhao** received the B.Sc. degree in electrical engineering from Dalian Maritime University, Dalian, China, in 1982, the M.Sc. and Ph.D. degrees from Northeastern University, Shenyang, China, in 1987 and 1995, respectively, both in computer science. He is currently with the Department of Computer Science and Technology, Northeastern University, Shenyang, China, where he is a professor and doctoral supervisor, and serves as the director of Liaoning Provincial Key Laboratory of Embedded Technology. His current research interests focus on

embedded Internet technology, wireless sensor network, pervasive computing, operating system, data and information fusion, computer simulation and virtual reality, etc.. He has held programs such as National Natural Science Foundation of China, National High Technology Research and Development Program of China, Nation Class Lighted Torch Plan, etc. He has published more than 300 academic papers, four books, and one national standard. He has successfully applied 10 patents, and received six awards for science and technology from the Liaoning province and ministry of China. He received allowance of the State Council due to his special contributions to the development of education.