

Mobility-Aware Call Admission Control Algorithm With Handoff Queue in Mobile Hotspots

Younghyun Kim, Haneul Ko, Sangheon Pack, *Senior Member, IEEE*,
Wonjun Lee, *Senior Member, IEEE*, and Xuemin (Sherman) Shen, *Fellow, IEEE*

Abstract—In this paper, we propose a mobility-aware call admission control (MA-CAC) algorithm with a handoff queue (HQ) in mobile hotspots, where different admission control policies are employed, depending on the vehicle mobility. Specifically, when a vehicle is static, a handoff priority scheme with guard channels is studied to protect vehicular handoff users because handoff users may get on the vehicle. In addition, an HQ is examined during stopping to further accept handoff users. On the other hand, for a moving vehicle, no guard channels for handoff users are allocated to maximize channel utilization. By means of Markov chains, we evaluate MA-CAC with an HQ in terms of new-call blocking probability (NCBP), handoff-call dropping probability (HCDP), handoff-call waiting time in the HQ, and channel utilization. Analytical and simulation results demonstrate that MA-CAC with an HQ can lower both the HCDP and the NCBP while maintaining high channel utilization.

Index Terms—Channel utilization, handoff-call dropping probability (HCDP), handoff queue (HQ), Markov chain, mobile hotspot, mobility-aware call admission control (MA-CAC), new-call blocking probability (NCBP).

I. INTRODUCTION

CURRENTLY, high-speed rail systems in Korea [also known as the *Korea Train eXpress* (KTX)] provide in-vehicle wireless Internet services by means of internal wireless local area network (WLAN) connections and external high-speed downlink packet access (HSDPA) connections. In addition, portable mobile relays, which are gateways between WLANs and HSDPA or mobile Worldwide Interoperability for Microwave Access (also known as *WiBro* in Korea), allow Internet access via WLAN interfaces, and they are available on

Manuscript received July 30, 2012; revised December 19, 2012; accepted January 15, 2013. Date of publication February 7, 2013; date of current version October 12, 2013. This work was supported in part by the National Research Foundation of Korea under Grant 2012R1A1B4000894 and Grant 2012K2A1A2032693 and in part by the Korean Ministry of Education, Science, and Technology under World Class University Project R33-2008-000-10044-0. The review of this paper was coordinated by Dr. T. Taleb. An earlier version of this paper was presented at the IEEE Global Telecommunications Conference, Miami, FL, USA, December 2010.

Y. Kim, H. Ko, and S. Pack are with the School of Electrical Engineering, Korea University, Seoul 136-701, Korea (e-mail: younghyun_kim@korea.ac.kr; st_basket@korea.ac.kr; shpack@korea.ac.kr).

W. Lee is with the Department of Computer Science and Engineering, Korea University, Seoul 136-701, Korea (e-mail: wlee@korea.ac.kr).

X. Shen is with the Department of Electrical and Computer Engineering, University of Waterloo, Waterloo, ON N2L 3G1, Canada (e-mail: xshen@bcr.uwaterloo.ca).

Color versions of one or more of the figures in this paper are available online at <http://ieeexplore.ieee.org>.

Digital Object Identifier 10.1109/TVT.2013.2245928

the market (e.g., Egg from Korea Telecom). Moreover, Seoul City has started free Internet services in taxis using these mobile relays. Since users spend increasingly more time in vehicles (e.g., cars, buses, subways, and trains), these services (referred to as mobile hotspots [2]) will be more popular in the future.

Recently, extensive studies have been conducted for mobile hotspots in terms of mobility management, quality-of-service (QoS) provision, and performance evaluation. Pack *et al.* [2] compared a network mobility (NEMO) basic support protocol with a session-initiation-protocol-based (SIP) NEMO support protocol in terms of handoff latency. Under SIP-NEMO environments, Chiang *et al.* [3] proposed a proxy-aided simultaneous handover mechanism, in which a session control manager for simultaneous handover in mobile hotspots was introduced. In [4], Zhang *et al.* introduced an intracluster communication scheme to guarantee seamless handoff in mobile hotspots.

QoS support in mobile hotspots was investigated in several works. Lera *et al.* [5] developed an architecture for two-hop communications based on both the universal mobile telecommunications system and IEEE 802.11. Niyato and Hossain [6] proposed bandwidth allocation schemes in heterogeneous multihop wireless networks, but mobility was not investigated in detail. Wang *et al.* [7] introduced a bandwidth-sharing reservation scheme for reserving resources between a mobile router (MR) and its home agent (HA) to overcome the problem of mobile resource reservation protocols in mobile hotspots. In [8], Lee *et al.* devised a QoS-enabled handover, in which the MR negotiates the aggregate QoS requirements of its attached MNs.

The performance of mobile hotspots was evaluated by analysis, simulations, and experiments. Perera *et al.* [9] implemented a mobile hotspot system consisted of an MR and NEMO-capable HA prototypes and demonstrated that duplicate address detection latency is significant in mobile hotspots. Song *et al.* [10] analyzed the delay performance in mobile hotspots under the assumption that a vehicle is always moving: In other words, getting on/off events, which are unique features of mobile hotspots, were not considered. Pack *et al.* [11] conducted the throughput analysis of Transmission Control Protocol-friendly rate control in mobile hotspots by developing discrete-time queueing models for links with wireless wide area networks (WWANs) and WLANs.

In our previous work [12], unique features (i.e., heterogeneous wireless links with WLANs and WWANs) in mobile hotspots were identified and analyzed. In addition, the results in [11] and [12] revealed that an efficient resource management is indispensable in mobile hotspots. Moreover, our measurement

study [13] in KTX and cars confirmed that current Internet services in mobile hotspots are not satisfactory due to the absence of resource management schemes. In particular, uplink throughput is unmatched with the requirements of interactive multimedia applications such as multimedia or voice over Internet Protocol (VoIP).

In mobile hotspots, handover from an external base station (BS) to an access point (AP) at the vehicle is needed since handover allows a user to be connected to the WLAN AP with better channel conditions and a low (or zero) connection fee. In such a handover scenario, call admission control (CAC) at the AP is indispensable for QoS provision. In particular, since the WLAN capacity is shared by multiple vehicular users and session-oriented applications (e.g., VoIP) are sensitive to disconnection/disruption due to handover, a well-defined CAC algorithm should be devised to satisfy QoS requirements in mobile hotspots. However, to the best of our knowledge, no works on CAC in mobile hotspots have been reported in the literature.

In this paper, we propose a mobility-aware CAC (MA-CAC) algorithm with a handoff queue (HQ) in mobile hotspots. MA-CAC with an HQ introduces two phases: stop and moving. At the stop phase, a vehicle stays at a location (e.g., a bus stop or a subway station); thus, vehicular users can join the AP (i.e., riding on the vehicle). In this situation, a handoff priority scheme with guard channels is examined to protect vehicular handoff users¹ from vehicular new users. On the other hand, at the moving phase, there are no vehicular handoff users since no one can ride on the moving vehicle. Hence, no guard channels for handoff users are allocated to maximally utilize the AP resource. In addition, to further reduce the handoff-call dropping, an HQ is adopted when all channels are occupied at the stop. By means of Markov chains, we evaluate MA-CAC with an HQ in terms of new-call blocking probability (NCBP), handoff-call dropping probability (HCDP), waiting time in the HQ, and channel utilization. Analytical and simulation results demonstrate that MA-CAC with an HQ can lower both HCDP and NCBP with high channel utilization. Note that the performance of MA-CAC with an HQ is not highly affected by the amount of guard channels, whereas the performance of existing CAC algorithms is sensitive to the number of reserved channels for handoff calls. Furthermore, we establish an optimization problem for determining the HQ size by considering HCDP, NCBP, waiting time in the HQ, and channel utilization.

The main contribution of this paper is twofold: 1) We propose a novel CAC scheme in mobile hotspots, and 2) we develop analytical models for MA-CAC with an HQ and validate the analytical results by extensive simulations.

The remainder of this paper is organized as follows. Section II presents the system model, and Section III describes MA-CAC with an HQ. Analytical models based on Markov chains are derived, and numerical results are given in Sections IV and V, respectively. Finally, Section VI concludes this paper.

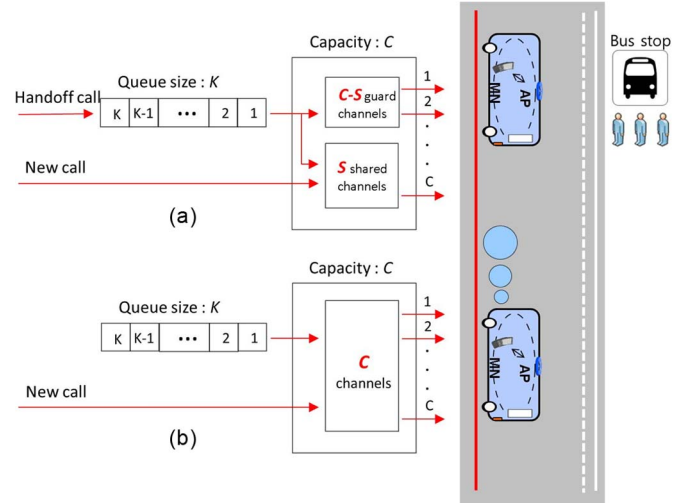

Fig. 1. Channel allocation in MA-CAC with an HQ.

II. SYSTEM MODEL

Consider a scenario where a vehicular user with an ongoing call rides on a vehicle. Then, the vehicular user should perform a handoff from the BS to the AP installed in the vehicle; thus, the call is referred to as a handoff call. On the other hand, the vehicular user can initiate a new call after riding on the vehicle, and then the call is considered as a new call with respect to the AP.

In mobile hotspots, there are two types of handoff events: The first event is from the AP to the BS, and the second event is from the BS to the AP. For a former handoff, general CAC algorithms will be performed at the BS. On the other hand, for a latter case, a new CAC algorithm is needed to consider vehicular mobility, which is the motivation of this paper. Therefore, hereinafter, we consider only the handoff from the BS to the AP or CAC at the AP.

CAC algorithms achieve efficient resource management by limiting the number of admitted calls and by ensuring QoS to users. Since mobile users experience severe service disruption when handoff calls are dropped, many CAC algorithms employ guard channels for prioritizing and protecting handoff calls. MA-CAC with an HQ adopts the concept of guard channels for handoff calls from the BS to the AP. However, unlike the existing CAC algorithms [15]–[17], the guard channels are dynamically assigned depending on the vehicular mobility. That is, some guard channels are allocated for handoff calls when the vehicle is static (e.g., at the stop) and vehicular users are riding on. On the other hand, since handoff calls cannot be generated during the movement of the vehicle, the remaining WLAN channels can be used by new calls with no guard channels.

Although the guard channels are employed, handoff calls can be dropped if no more channels are available since new calls can utilize all channels during the moving phase. Therefore, to handle this case, an HQ is installed at the AP. As shown in Fig. 1, a first-in–first-out HQ with finite size K can accommodate more handoff calls if no channels are available and the HQ is not full. A handoff-call waiting in the head of queue is dispatched and serviced immediately when a channel becomes free. However,

¹Vehicular handoff users refer to those that have made calls with an external BS and perform a handoff from the external BS to the AP at the vehicle [14].

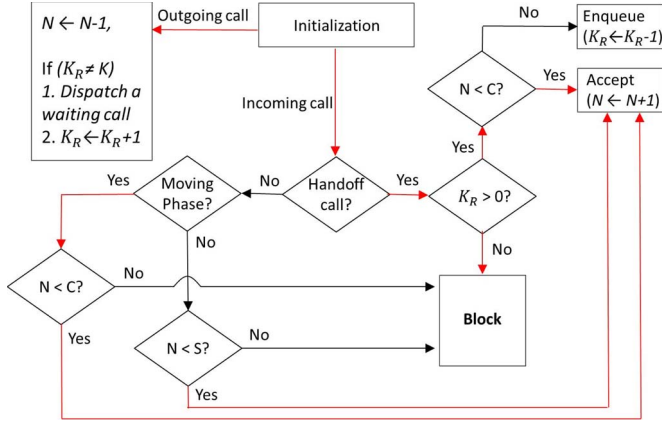

Fig. 2. MA-CAC with an HQ.

a large size HQ (i.e., large K) can increase the waiting time of handoff calls; thus, an appropriate queue size K should be carefully determined.

Finally, to describe MA-CAC with an HQ, we consider the discrete WLAN capacity as in [18], i.e., the WLAN capacity is denoted by C bandwidth units, as shown in Fig. 1. This WLAN capacity C can be determined by considering service requirements, e.g., VoIP capacity can be obtained as [19]. In addition, we assume that each call requires a single bandwidth unit.

III. MOBILITY-AWARE CALL ADMISSION CONTROL WITH A HANDOFF QUEUE

MA-CAC with an HQ defines two phases: stop and moving. At the stop phase, the vehicular users can ride on or get off the vehicle. In other words, handoff calls are generated only at the stop phase. Therefore, MA-CAC with an HQ sets guard channels for ensuring higher priorities to handoff calls. Specifically, MA-CAC with an HQ employs a cutoff priority (CP) scheme in which a fixed number of channels (i.e., $C - S$ channels) are exclusively used for handoff calls [20]. As mentioned in Section II, the HQ is also adopted to further reduce handoff-call dropping events.

After stopping at a location, the vehicle moves to another location, and then, the phase is changed from the stop phase to the moving phase. Since no vehicular users can ride on the vehicle during the moving phase, we do not need to consider any handoff calls for CAC. In other words, it is wasteful to reserve a portion of channels (i.e., guard channels) for handoff calls during the moving phase. Consequently, the total WLAN capacity C can be used by new calls at the moving phase. In addition, the HQ is closed to new calls during the moving phase to accept more handoff calls when the vehicle stops at the next station.

Fig. 2 shows the flowchart of MA-CAC with an HQ. N is the number of calls currently served by the AP. In addition, K_R represents the remaining queue size. When a call departs from the AP (i.e., call termination or user take-off), N is decremented by 1, and a waiting call is dispatched if there exist some calls in the HQ. On the other hand, if there is an incoming call, its type (either handoff or new) should be first evaluated. When the incoming call is a handoff call, the AP accepts it if there are free

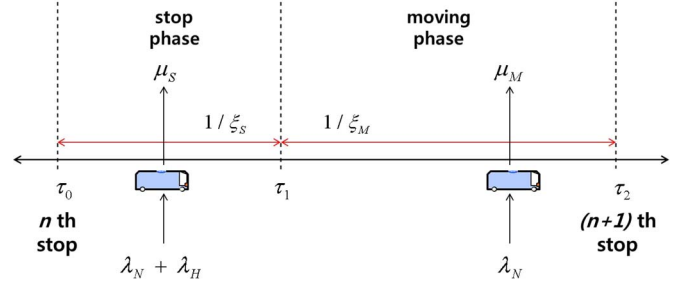

Fig. 3. System model for performance analysis.

channels at the AP (i.e., N is less than C) or the HQ is not full. In other words, if N is less than $C + K$, the handoff call can be accepted. On the contrary, if the incoming call is a new call, the phase of the vehicle should be examined since the number of channels allocated for new calls depends upon the phase. If the vehicle is in the moving phase, the new call can be accepted when N is less than C . On the contrary, the new call can be admitted only if N is less than S when the vehicle is at the stop phase.

Recent mobile terminals have multiple interfaces, such as WLANs and WWANs. Hence, the blocked call can be redirected to cellular networks in WLAN/cellular interworking systems. This is another interesting topic in mobile hotspots, which is one of our future works.

IV. PERFORMANCE ANALYSIS

To develop an analytical model, we consider a stochastic process for mobile hotspots, as shown in Fig. 3. From τ_0 to τ_1 , a vehicle is in the stop phase. During this time period, both handoff and new calls can be generated. We assume that the arrival processes of handoff calls and new calls follow Poisson distributions with rates λ_H and λ_N , respectively. Then, the total call arrival rate in the stop phase is drawn from the Poisson process with rate $\lambda_H + \lambda_N$. On the other hand, the call duration time in the stop phase follows an exponential distribution with mean $1/\mu_S$. In addition, the dwell time in the stop phase follows an exponential distribution with mean $1/\xi_S$. Note that there are no users riding a vehicle in the moving phase (i.e., from τ_1 to τ_2). Hence, the new-call arrival process in the moving phase is given by a Poisson process with rate λ_N . In addition, the call duration and the dwell time in the moving phase follow exponential distributions with means $1/\mu_M$ and $1/\xi_M$, respectively.

A. MA-CAC with an HQ

Based on the given assumptions, we have a state transition diagram for MA-CAC with an HQ, as shown in Fig. 4 [21]. In state (i, j) , i represents the phase (i.e., either stop ($i = 0$) or moving ($i = 1$)), and j is the number of calls in the system. Therefore, the state space is given by $S = \{(i, j) | i \in \{0, 1\}, 0 \leq j \leq C + K\}$, where C and K are the capacities of the AP and the HQ size, respectively. In the stop phase, since MA-CAC with an HQ employs the CP scheme in which a fixed number of channels (i.e., $C - S$ channels) are exclusively reserved for handoff calls [20], only handoff calls can be

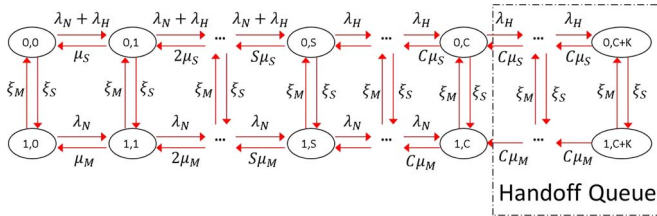

Fig. 4. Two-dimensional continuous-time Markov chain for MA-CAC with an HQ.

accepted when $i = 0$ and $j \geq S$. On the other hand, in the moving phase, MA-CAC with an HQ allows all available channels can be used by new calls. In the stop (or moving) phase, the call departure rates at each state are $j \cdot \mu_S$ (or $j \cdot \mu_M$) by the memoryless property when $j \leq C$. On the other hand, when $C < j \leq C + K$, the call departure rates become $C \cdot \mu_S$ and $C \cdot \mu_M$ at the stop and moving phases, respectively, since the total capacity of the AP is C . Finally, the phase transition rates from the moving phase to the stop phase, and *vice versa*, are ξ_M and ξ_S , respectively. Let $p(i, j; \bar{i}, \bar{j})$ be the transition rate from state (i, j) to state (\bar{i}, \bar{j}) . Then, the transition rates are summarized as

$$\begin{aligned}
 p(0, j; 1, j) &= \xi_S, & \text{for } 0 \leq j \leq C + K \\
 p(1, j; 0, j) &= \xi_M, & \text{for } 0 \leq j \leq C + K \\
 p(0, j; 0, j + 1) &= \lambda_N + \lambda_H, & \text{for } 0 \leq j < S \\
 p(0, j; 0, j + 1) &= \lambda_H, & \text{for } S \leq j < C + K \\
 p(0, j; 0, j - 1) &= j \cdot \mu_S, & \text{for } 0 < j \leq C \\
 p(0, j; 0, j - 1) &= C \cdot \mu_S, & \text{for } C < j \leq C + K \\
 p(1, j; 1, j + 1) &= \lambda_N, & \text{for } 0 \leq j < C \\
 p(1, j; 1, j - 1) &= j \cdot \mu_M, & \text{for } 0 < j \leq C \\
 p(1, j; 1, j - 1) &= C \cdot \mu_M, & \text{for } C < j \leq C + K. \quad (1)
 \end{aligned}$$

To find out the steady-state probability of MA-CAC with an HQ, i.e., $\pi_{i,j}$, we have the following balance equations in Fig. 4.

1) When $i = 0$ and $j = 0$, we have

$$((\lambda_N + \lambda_H) + \xi_S) \pi_{i,j} = (j + 1) \mu_S \pi_{i,j+1} + \xi_M \pi_{1,j}.$$

2) When $i = 0$ and $0 < j < S$, we have

$$\begin{aligned}
 ((\lambda_N + \lambda_H) + j \mu_S + \xi_S) \pi_{i,j} \\
 = (\lambda_N + \lambda_H) \pi_{i,j-1} + (j + 1) \mu_S \pi_{i,j+1} + \xi_M \pi_{1,j}.
 \end{aligned}$$

3) When $i = 0$ and $j = S$, we have

$$\begin{aligned}
 (\lambda_H + j \mu_S + \xi_S) \pi_{i,j} \\
 = (\lambda_N + \lambda_H) \pi_{i,j-1} + (j + 1) \mu_S \pi_{i,j+1} + \xi_M \pi_{1,j}.
 \end{aligned}$$

4) When $i = 0$ and $S < j < C$, we have

$$(\lambda_H + j \mu_S + \xi_S) \pi_{i,j} = \lambda_H \pi_{i,j-1} + (j + 1) \mu_S \pi_{i,j+1} + \xi_M \pi_{1,j}.$$

5) When $i = 0$ and $C \leq j < C + K$, we have

$$(\lambda_H + C \mu_S + \xi_S) \pi_{i,j} = \lambda_H \pi_{i,j-1} + C \mu_S \pi_{i,j+1} + \xi_M \pi_{1,j}.$$

6) When $i = 0$ and $j = C + K$, we have

$$(C \mu_S + \xi_S) \pi_{i,j} = \lambda_H \pi_{i,j-1} + \xi_M \pi_{1,j}.$$

7) When $i = 1$ and $j = 0$, we have

$$(\lambda_N + \xi_M) \pi_{i,j} = (j + 1) \mu_M \pi_{i,j+1} + \xi_S \pi_{0,j}.$$

8) When $i = 1$ and $0 < j < C$, we have

$$(\lambda_N + j \mu_M + \xi_M) \pi_{i,j} = \lambda_N \pi_{i,j-1} + (j + 1) \mu_M \pi_{i,j+1} + \xi_S \pi_{0,j}.$$

9) When $i = 1$ and $j = C$, we have

$$(j \mu_M + \xi_M) \pi_{i,j} = \lambda_N \pi_{i,j-1} + C \mu_M \pi_{i,j+1} + \xi_S \pi_{0,j}.$$

10) When $i = 1$ and $C < j < C + K$, we have

$$(C \mu_M + \xi_M) \pi_{i,j} = C \mu_M \pi_{i,j+1} + \xi_S \pi_{0,j}.$$

11) When $i = 1$ and $j = C + K$, we have

$$(C \mu_M + \xi_M) \pi_{i,j} = \xi_S \pi_{0,j}. \quad (2)$$

Since it is hard to derive any closed forms for $\pi_{i,j}$, we utilize an iterative algorithm [22] for obtaining $\pi_{i,j}$.

In terms of the NCBP, a new call is blocked when the number of occupied channels is equal to or larger than S in the stop phase. On the other hand, in the moving phase, a new call is rejected only when all channels are busy. Thus, the NCBP of MA-CAC with an HQ can be obtained as

$$P_{\text{NCBP}} = \sum_{j=S}^{C+K} \pi_{0,j} + \sum_{j=C}^{C+K} \pi_{1,j}. \quad (3)$$

On the other hand, a handoff call can be generated only at the stop phase. In addition, the handoff call can be blocked when there is no free space at the AP and the HQ. Consequently, the HCDP is given by

$$P_{\text{HCDP}} = P(j = C + K | i = 0) = \frac{\pi_{0,C+K}}{\sum_{j=0}^{C+K} \pi_{0,j}}. \quad (4)$$

When we design CAC algorithms, how to efficiently utilize resources is an important issue. Therefore, we define the channel utilization as the ratio of the expected number of used channels to the total capacity. Then, the channel utilization U can be obtained as

$$U = \frac{\sum_{i=0}^{i=1} \sum_{j=0}^{j=C} j \cdot \pi_{i,j}}{C} + \frac{\sum_{i=0}^{i=1} \sum_{j=C+1}^{j=C+K} C \cdot \pi_{i,j}}{C}. \quad (5)$$

To derive the average handoff-call waiting time W_Q in the HQ, the average number of calls in the HQ can be first computed as

$$N_Q = \sum_{i=0}^{i=1} \sum_{j=C+1}^{j=C+K} (j - C) \cdot \pi_{i,j}. \quad (6)$$

On the other hand, by considering the vehicle's phase, the effective arrival rate can be obtained as

$$\lambda_e = \sum_{j=0}^{S-1} (\lambda_N + \lambda_H) \cdot \pi_{0,j} + \sum_{j=S}^{C+K-1} \lambda_H \cdot \pi_{0,j} + \sum_{j=0}^{C-1} \lambda_N \cdot \pi_{1,j}. \quad (7)$$

Then, by Little's law [23], W_Q is given by

$$W_Q = \frac{N_Q}{\lambda_e}. \quad (8)$$

B. NP Scheme

We then analyze the performance of the nonpriority (NP) scheme in which no channels are reserved for handoff calls regardless of the phase. Since both new and handoff calls can be accepted until the AP capacity is fully occupied, the transition rates for the NP scheme are given by

$$\begin{aligned} p(0, j; 1, j) &= \xi_S, & (0 \leq j \leq C) \\ p(1, j; 0, j) &= \xi_M, & (0 \leq j \leq C) \\ p(0, j; 0, j-1) &= j\mu_S, & (0 < j \leq C) \\ p(0, j; 0, j+1) &= \lambda_N + \lambda_H, & (0 \leq j < C) \\ p(1, j; 1, j-1) &= j\mu_M, & (0 < j \leq C) \\ p(1, j; 1, j+1) &= \lambda_N, & (0 \leq j < C). \end{aligned} \quad (9)$$

Similar to MA-CAC with an HQ, the steady-state probability in the NP scheme $\pi_{i,j}^{\text{NP}}$ can be obtained from the balance equations (see Appendix A) by means of an iterative algorithm.

Because both new calls and handoff calls are blocked only when j is equal to C , NCBP and HCDP of the NP scheme are given, respectively, by

$$P_{\text{NCBP}}^{\text{NP}} = \pi_{0,C}^{\text{NP}} + \pi_{1,C}^{\text{NP}} \quad (10)$$

$$P_{\text{HCDP}}^{\text{NP}} = \frac{\pi_{0,C}^{\text{NP}}}{\sum_{j=0}^C \pi_{0,j}^{\text{NP}}}. \quad (11)$$

In addition, similar to (5), the channel utilization of the NP scheme is given by

$$U^{\text{NP}} = \frac{\sum_{j=0}^C j (\pi_{0,j}^{\text{NP}} + \pi_{1,j}^{\text{NP}})}{C}. \quad (12)$$

C. CP Scheme

The CP scheme always preserves $C-S$ guard channels for handoff calls during the moving and stop phases. Hence, the transition rates for the CP scheme are given by

$$\begin{aligned} p(0, j; 1, j) &= \xi_S, & (0 \leq j \leq C) \\ p(1, j; 0, j) &= \xi_M, & (0 \leq j \leq C) \\ p(0, j; 0, j-1) &= j\mu_S, & (0 < j \leq C) \\ p(0, j; 0, j+1) &= \lambda_N + \lambda_H, & (0 \leq j < S) \\ p(0, j; 0, j+1) &= \lambda_H, & (S \leq j < C) \\ p(1, j; 1, j-1) &= j\mu_M, & (0 < j \leq C) \\ p(1, j; 1, j+1) &= \lambda_N, & (0 \leq j < S). \end{aligned} \quad (13)$$

The balance equations for obtaining the steady-state probability $\pi_{i,j}^{\text{CP}}$ in the CP scheme can be found in Appendix B.

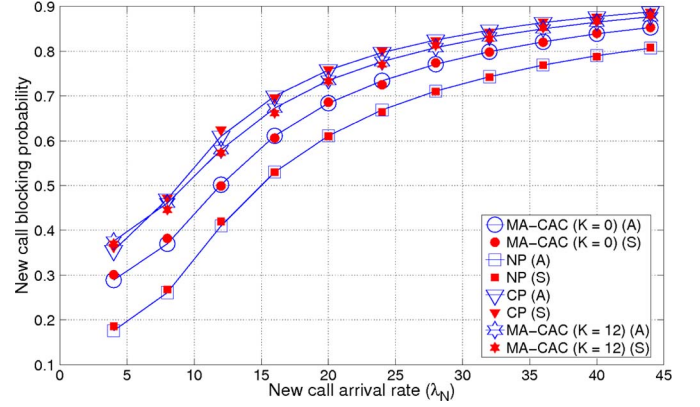

Fig. 5. NCBP versus λ_N (A: analytical results; S: simulation results).

Since a new call is blocked when $j \geq S$ in the CP scheme, NCBP can be obtained from

$$P_{\text{NCBP}}^{\text{CP}} = \sum_{j=S}^C (\pi_{0,j}^{\text{CP}} + \pi_{1,j}^{\text{CP}}). \quad (14)$$

On the other hand, since handoff calls are dropped only when there is no available channel in the stop phase, the HCDP of the CP scheme is given by

$$P_{\text{HCDP}}^{\text{CP}} = \frac{\pi_{0,C}^{\text{CP}}}{\sum_{j=0}^C \pi_{0,j}^{\text{CP}}}. \quad (15)$$

Finally, the channel utilization of the CP scheme U^{CP} can be obtained from

$$U^{\text{CP}} = \frac{\sum_{j=0}^C j (\pi_{0,j}^{\text{CP}} + \pi_{1,j}^{\text{CP}})}{C}. \quad (16)$$

V. NUMERICAL RESULTS

Here, we evaluate the performance of MA-CAC with an HQ against the CP and NP schemes in terms of NCBP, HCDP, channel utilization, and queue waiting time. For numerical analysis, we assume that the WLAN of the mobile hotspot is based on IEEE 802.11b whose nominal data rate is 11 Mb/s. Since it is known that the effective maximum throughput of IEEE 802.11b is 7.4 Mb/s [18], the WLAN capacity C is set to $7.4/0.128 \approx 58$ for video calls of 128 kb/s. The default value of S is assigned by 50, but we investigate the effect of S in Section V-C. Moreover, the mean call durations in the stop and moving phases $1/\mu_S$ and $1/\mu_M$ are both set to 6. In addition, ξ_S and ξ_M are $1/3$ and $1/6$, respectively. λ_H is fixed at 24, whereas λ_N is varied. To verify the analytical results, we have developed an event-driven simulator and conducted ten simulation runs with different seed values independently, where a vehicle experiences 100 stop phases and moving phases, respectively.

A. Effects of λ_N

Fig. 5 shows NCBP as the new-call arrival rate increases. In Fig. 5, it can be observed that NCBPs of MA-CAC with an HQ, and the NP/CP schemes become higher with the increase in the new-call arrival rate. In addition, the CP scheme has the

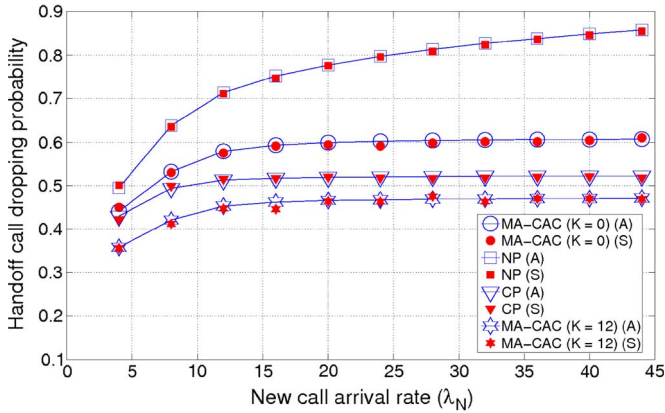

Fig. 6. HCDP versus λ_N .

highest NCBP among three schemes since a portion of channels is exclusively used for handoff calls. On the other hand, the NP scheme has the lowest NCBP because the NP scheme can accept new calls until the AP capacity is fully occupied. Since MA-CAC with an HQ reserves $C-S$ channels for handoff calls during the stop phase, it exhibits slightly higher NCBP than the NP scheme. In addition, it can be observed that the NCBP of MA-CAC with a larger queue (i.e., $K = 12$) is higher than that of MA-CAC with no queue since more handoff calls are accumulated at the HQ, and these handoff calls are dispatched from the queue as soon as any channel is released.

HCDP as a function of λ_N is shown in Fig. 6. It can be seen that MA-CAC without an HQ has higher HCDP than the CP scheme since MA-CAC without an HQ reserves channels only during the stop phase and releases them during the moving phase. In the case of the CP scheme, it preserves $C-S$ channels for handoff calls, even during the moving phase. Hence, HCDP in the CP scheme can be lower than that in the MA-CAC without a queue. This shortcoming can be addressed by adopting the HQ. As shown in Fig. 6, when K is 12, MA-CAC with an HQ has the lowest HCDP since handoff calls can wait in the HQ, although there is no available channel when the vehicle arrives at the station. The effect of the HQ size will be elaborated in Section V-B. In Figs. 5 and 6, the average values of each scheme are obtained and plotted from simulations, and it can be found that simulation results are consistent with analytical results.

The channel utilization is described in Fig. 7. Intuitively, it can be seen that the CP scheme has the lowest channel utilization since it wastes $C-S$ channels during the moving phase. On the contrary, it can be found that MA-CAC with an HQ can achieve comparable channel utilization to the NP scheme, regardless of K . To conclude, MA-CAC with an HQ can efficiently utilize the channel as the NP scheme while providing lower HCDP than the NP scheme.

To consider more realistic environments, we conduct more simulations by assuming that the dwell time in the stop and moving phases follows Gamma distributions. Gamma distribution is widely accepted for comprehensive simulations because it is versatile and can emulate any general distribution by selecting appropriate mean and variance [24].

Figs. 8 and 9 show NCBPs and HCDPs where the variances of the dwell time in the stop and moving phases are high, i.e., the variance is ten times larger than Figs. 5 and 6.

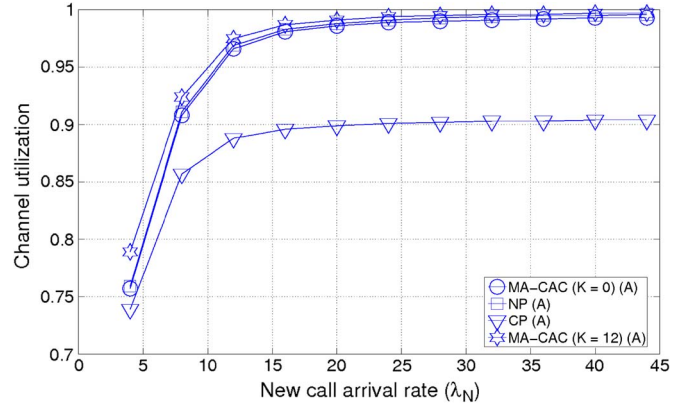

Fig. 7. Channel utilization versus λ_N .

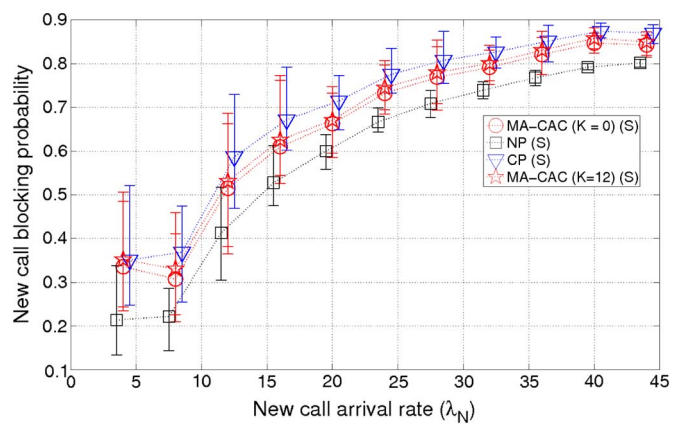

Fig. 8. NCBP versus λ_N (Gamma distribution with variances $10/\epsilon_S^2$ and $10/\epsilon_M^2$).

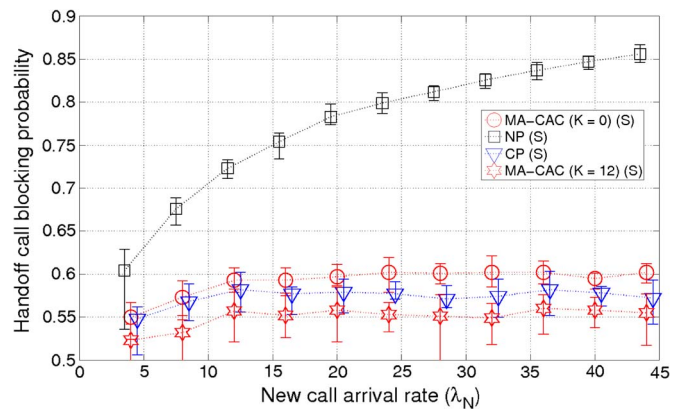

Fig. 9. HCDP versus λ_N (Gamma distribution with variances $10/\epsilon_S^2$ and $10/\epsilon_M^2$).

In Fig. 8, it can be observed that NCBPs fluctuate widely, whereas the average values of each scheme follow similar tendencies with that in Fig. 5. On the other hand, the range of fluctuation in HCDP is smaller than that in NCBP, as shown in Fig. 9. This is because handoff calls are generated only in the stop phase, whereas new calls can occur both in the stop and moving phases. Hence, the variances of the dwell time in the stop and moving phases have limited impact on HCDP. Consequently, it can be concluded that MA-CAC with an HQ can work well under diverse environments.

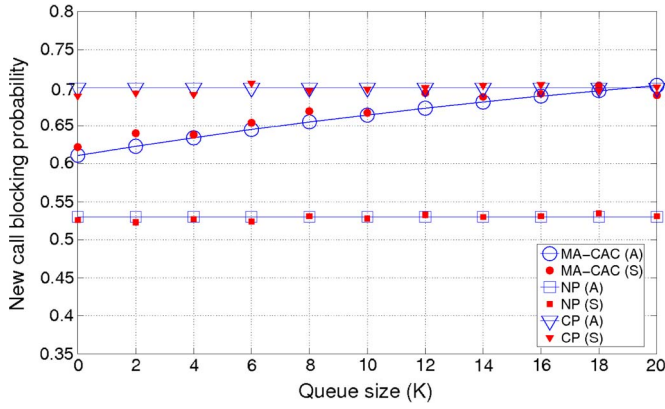

Fig. 10. NCBP versus K ($\lambda_N = 16$).

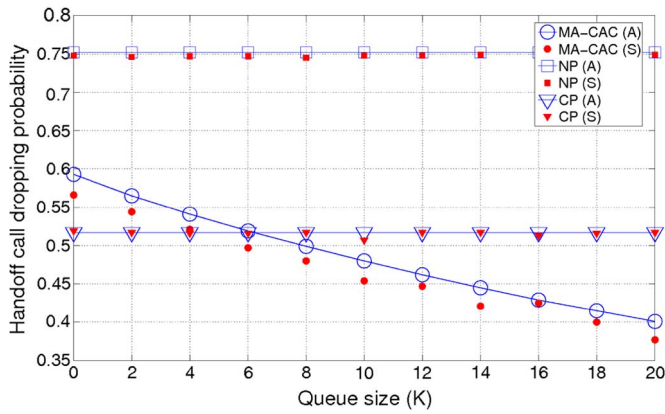

Fig. 11. HCDP versus K ($\lambda_N = 16$).

B. Effects of K

Figs. 10 and 11 show the effects of HQ size K on NCBP and HCDP, respectively. In Fig. 10, it can be observed that the NCBP of MA-CAC with an HQ increases as K increases since more handoff calls are accumulated at the HQ. On the other hand, the HCDP of MA-CAC with an HQ decreases proportionally to K , as shown in Fig. 11. In short, an appropriate K should be selected by striking the balance between NCBP and HCDP.

In terms of selecting K , the HQ waiting time should be also taken into account. Fig. 12 shows the HQ waiting time W_Q as a function of the queue size K . Apparently, W_Q increases as K increases. Since users are sensitive to the increased W_Q , the HQ waiting time should be bounded. Based on these observations, we establish an optimization problem for choosing K as

$$\begin{aligned} & \max_K U \\ & \text{s.t. } P_{\text{NCBP}} \leq \alpha, P_{\text{HCDP}} \leq \beta, W_Q \leq \gamma \end{aligned}$$

where α , β , and γ are the threshold values for P_{NCBP} , P_{HCDP} , and W_Q , respectively. α and β are system parameters, and γ can be set by considering the characteristics of target applications. For example, delay-sensitive VoIP applications require smaller values of γ to limit the HQ waiting time. Using Fig. 7, Figs. 10–12, the optimal K solving the given optimization problem can be easily obtained. Assume that $\alpha = 0.7$, $\beta = 0.5$, and $\gamma = 25$. Then, the NCDP and the HCDP should be less than

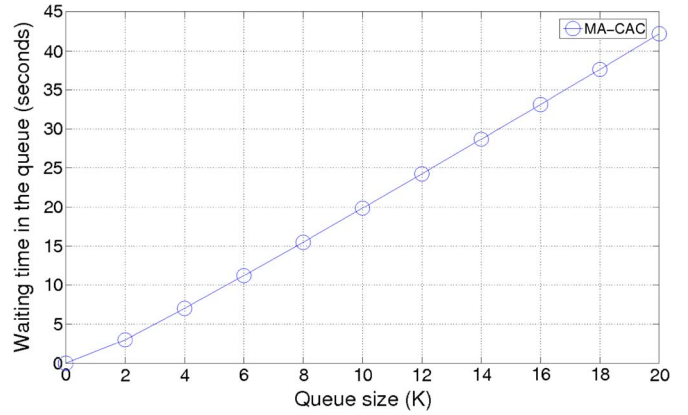

Fig. 12. Waiting time in the queue versus K ($\lambda_N = 16$).

0.7 and 0.5, respectively, and the HQ waiting time should be bounded to 25 s. Then, the optimal K is determined as 12 since any K larger than 12 cannot satisfy the constraints on P_{NCBP} , P_{HCDP} , and W_Q .

C. Effects of S

Table I demonstrates NCBP, HCDP, and the channel utilization as a function of S , which determines the amount of reserved channels. Since a smaller S means that more channels are reserved for handoff calls, NCBPs of MA-CAC with an HQ and the CP scheme increase as S decreases. On the contrary, lower HCDP is observed when more channels are reserved, i.e., S is small. In addition, Table I indicates that the channel utilization becomes low as more channels are exclusively reserved for handoff calls in the CP scheme.

Interestingly, it can be found that the performance of the CP scheme in terms of NCBP and HCDP is highly sensitive to S . Therefore, if an inappropriate S is set owing to dynamics in call arrival and duration patterns, the performance of the CP scheme can be significantly degraded. On the other hand, MA-CAC with an HQ shows almost constant NCBP and HCDP, regardless of S . This characteristic makes it easy to determine the appropriate S in MA-CAC with an HQ.

D. Effects of ξ_S

In Fig. 13, the effect of the dwell time in the stop phase $1/\xi_S$ is investigated. In Fig. 13, it can be observed that NCBPs of MA-CAC without a queue and the NP scheme converge into almost the same value as the dwell time in the stop phase becomes smaller. This is because MA-CAC without an HQ operates as the NP scheme during the moving phase if the dwell time in the stop phase is short; thus, the moving phase dominates. Similarly, in Fig. 13, it can be seen that the impact of the queue size diminishes in MA-CAC with an HQ as $1/\xi_S$ decreases. Hence, when $1/\xi_S$ is relatively very low, it does not need to carefully determine the queue size if NCBP is the only main factor for mobile hotspots.

Fig. 14 shows HCDP as a function of $1/\xi_S$. In Fig. 14, it can be found that HCDP of the CP scheme drastically decreases as $1/\xi_S$ decreases, whereas both MA-CAC without an HQ

TABLE I
EFFECTS OF S

		S	42	45	48	51	54	57
P_{NCBP}	MA-CAC ($K = 0$)	0.80	0.80	0.80	0.80	0.80	0.80	0.75
	MA-CAC ($K = 12$)	0.87	0.87	0.87	0.87	0.87	0.87	0.86
	NP scheme	0.65	0.65	0.65	0.65	0.65	0.65	0.65
	CP scheme	0.92	0.90	0.88	0.86	0.84	0.84	0.76
P_{HCDP}	MA-CAC ($K = 0$)	0.60	0.60	0.60	0.60	0.60	0.60	0.65
	MA-CAC ($K = 12$)	0.53	0.53	0.53	0.53	0.53	0.53	0.53
	NP scheme	0.76	0.76	0.76	0.76	0.76	0.76	0.76
	CP scheme	0.53	0.54	0.55	0.57	0.58	0.58	0.65
Channel utilization	MA-CAC ($K = 0$)	0.99	0.99	0.99	0.99	0.99	0.99	0.99
	MA-CAC ($K = 12$)	0.99	0.99	0.99	0.99	0.99	0.99	0.99
	NP scheme	0.99	0.99	0.99	0.99	0.99	0.99	0.99
	CP scheme	0.91	0.92	0.93	0.95	0.96	0.96	0.98

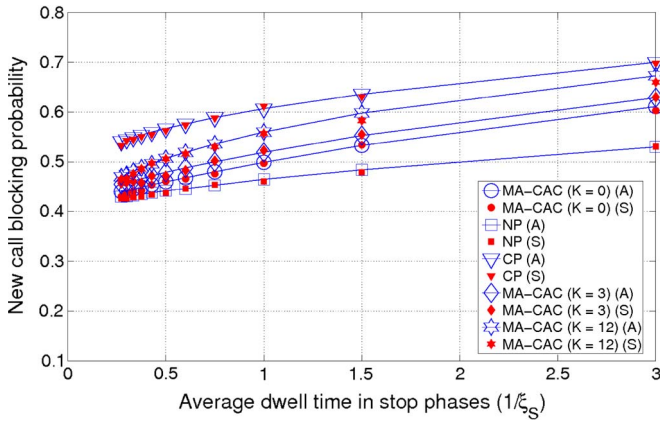

Fig. 13. NCBP versus $1/\xi_S$ ($\lambda_N = 16$).

and the NP scheme are not apparently affected by $1/\xi_S$. This can be explained as follows. When the dwell time in the stop phase is short (i.e., $1/\xi_S$ is short), fewer handoff calls are generated. Since the CP scheme reserves a fixed number of channels for handoff calls, the HCDP of the CP scheme is drastically reduced as $1/\xi_S$ decreases due to fewer handoff calls. On the contrary, MA-CAC without an HQ and the NP scheme do not prepare any guard channels and fully utilize C channels during the moving phase. Therefore, their HCDPs are not severely affected by the reduction of $1/\xi_S$. On the other hand, it can be shown that MA-CAC with an HQ can further reduce HCDP, particularly when the dwell time in the stop phase is short. This is because the HQ can be used for fewer handoff calls, similar to the reserved channels in the CP scheme.

VI. CONCLUSION

In this paper, we have proposed MA-CAC with an HQ in mobile hotspots, which introduces novel CAC schemes depending on the mobility. That is, guard channels are dynamically assigned only at the stop phase to prioritize handoff calls, whereas no guard channels are used during the moving phase to maximally utilize the WLAN capacity. The HQ is also installed at an AP to further reduce dropped handoff calls.

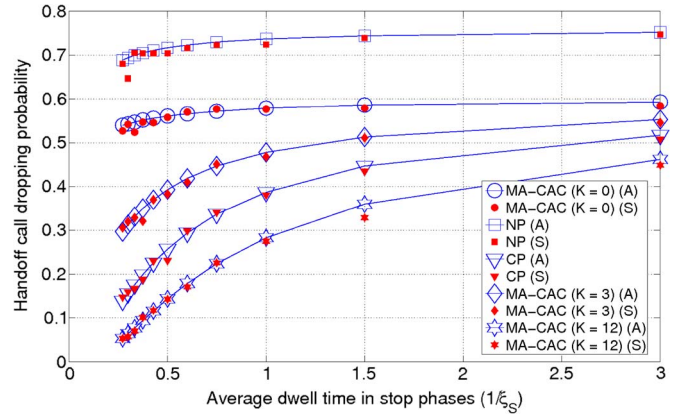

Fig. 14. HCDP versus $1/\xi_S$ ($\lambda_N = 16$).

Analytical and simulation results demonstrate that MA-CAC with an HQ can lower HCDP and NCBP while maintaining high channel utilization. MA-CAC with an HQ does not require any modifications to mobile nodes and complex functionalities. Therefore, it can be easily implemented at the AP for QoS-enabled mobile hotspots. In our future work, we will conduct trace-driven simulations and extend MA-CAC with an HQ for multiple service classes.

APPENDIX A

BALANCE EQUATIONS FOR THE NONPRIORITY SCHEME

The balance equations for the NP scheme are as follows.

1) When $i = 0$ and $j = 0$, we have

$$((\lambda_N + \lambda_H) + \xi_S) \pi_{i,j}^{NP} = (j + 1)\mu_S \pi_{i,j+1}^{NP} + \xi_M \pi_{1,j}^{NP}.$$

2) When $i = 0$ and $0 < j < C$, we have

$$\begin{aligned} ((\lambda_N + \lambda_H) + j\mu_S + \xi_S) \pi_{i,j}^{NP} \\ = (\lambda_N + \lambda_H) \pi_{i,j-1}^{NP} + (j + 1)\mu_S \pi_{i,j+1}^{NP} + \xi_M \pi_{1,j}^{NP}. \end{aligned}$$

3) When $i = 0$ and $j = C$, we have

$$(C\mu_S + \xi_S) \pi_{i,j}^{NP} = \lambda_H \pi_{i,j-1}^{NP} + \xi_M \pi_{1,j}^{NP}.$$

4) When $i = 1$ and $j = 0$, we have

$$(\lambda_N + \xi_M)\pi_{i,j}^{\text{NP}} = (j+1)\mu_M\pi_{i,j+1}^{\text{NP}} + \xi_S\pi_{0,j}^{\text{NP}}.$$

5) When $i = 1$ and $0 < j < C$, we have

$$(\lambda_N + j\mu_M + \xi_M)\pi_{i,j}^{\text{NP}} = \lambda_N\pi_{i,j-1}^{\text{NP}} + (j+1)\mu_M\pi_{i,j+1}^{\text{NP}} + \xi_S\pi_{0,j}^{\text{NP}}.$$

6) When $i = 1$ and $j = C$, we have

$$(j\mu_M + \xi_M)\pi_{i,j}^{\text{NP}} = \lambda_N\pi_{i,j-1}^{\text{NP}} + C\mu_M\pi_{i,j+1}^{\text{NP}} + \xi_S\pi_{0,j}^{\text{NP}}. \quad (\text{A.1})$$

APPENDIX B BALANCE EQUATIONS FOR THE CUTOFF PRIORITY SCHEME

The balance equations for the CP scheme are as follows.

1) When $i = 0$ and $j = 0$, we have

$$((\lambda_N + \lambda_H) + \xi_S)\pi_{i,j}^{\text{CP}} = (j+1)\mu_S\pi_{i,j+1}^{\text{CP}} + \xi_M\pi_{1,j}^{\text{CP}}.$$

2) When $i = 0$ and $0 < j < S$, we have

$$\begin{aligned} &((\lambda_N + \lambda_H) + j\mu_S + \xi_S)\pi_{i,j}^{\text{CP}} \\ &= (\lambda_N + \lambda_H)\pi_{i,j-1}^{\text{CP}} + (j+1)\mu_S\pi_{i,j+1}^{\text{CP}} + \xi_M\pi_{1,j}^{\text{CP}}. \end{aligned}$$

3) When $i = 0$ and $j = S$, we have

$$\begin{aligned} &(\lambda_H + j\mu_S + \xi_S)\pi_{i,j}^{\text{CP}} \\ &= (\lambda_N + \lambda_H)\pi_{i,j-1}^{\text{CP}} + (j+1)\mu_S\pi_{i,j+1}^{\text{CP}} + \xi_M\pi_{1,j}^{\text{CP}}. \end{aligned}$$

4) When $i = 0$ and $S < j < C$, we have

$$(\lambda_H + j\mu_S + \xi_S)\pi_{i,j}^{\text{CP}} = \lambda_H\pi_{i,j-1}^{\text{CP}} + (j+1)\mu_S\pi_{i,j+1}^{\text{CP}} + \xi_M\pi_{1,j}^{\text{CP}}.$$

5) When $i = 0$ and $j = C$, we have

$$(C\mu_S + \xi_S)\pi_{i,j}^{\text{CP}} = \lambda_H\pi_{i,j-1}^{\text{CP}} + \xi_M\pi_{1,j}^{\text{CP}}.$$

6) When $i = 1$ and $j = 0$, we have

$$(\lambda_N + \xi_M)\pi_{i,j}^{\text{CP}} = (j+1)\mu_M\pi_{i,j+1}^{\text{CP}} + \xi_S\pi_{0,j}^{\text{CP}}.$$

7) When $i = 1$ and $0 < j < S$, we have

$$\begin{aligned} &(\lambda_N + j\mu_M + \xi_M)\pi_{i,j}^{\text{CP}} \\ &= \lambda_N \cdot \pi_{i,j-1}^{\text{CP}} + (j+1)\mu_M\pi_{i,j+1}^{\text{CP}} + \xi_S\pi_{1,j}^{\text{CP}}. \end{aligned}$$

8) When $i = 1$ and $j = S$, we have

$$(j\mu_M + \xi_M)\pi_{i,j}^{\text{CP}} = \lambda_N \cdot \pi_{i,j-1}^{\text{CP}} + (j+1)\mu_M\pi_{i,j+1}^{\text{CP}} + \xi_S\pi_{1,j}^{\text{CP}}.$$

9) When $i = 1$ and $S < j < C$, we have

$$(j\mu_M + \xi_M)\pi_{i,j}^{\text{CP}} = (j+1)\mu_M\pi_{i,j+1}^{\text{CP}} + \xi_S\pi_{1,j}^{\text{CP}}.$$

10) When $i = 1$ and $j = C$, we have

$$(C\mu_M + \xi_M)\pi_{i,j}^{\text{CP}} = \xi_S\pi_{1,j}^{\text{CP}}. \quad (\text{A.2})$$

REFERENCES

- [1] Y. Kim, S. Pack, and W. Lee, "Mobility-aware call admission control algorithm in vehicular WiFi networks," in *Proc. IEEE GLOBECOM*, Dec. 2010, pp. 1–5.
- [2] S. Pack, X. Shen, J. Mark, and J. Pan, "Mobility management in mobile hotspots with heterogeneous multihop wireless links," *IEEE Commun. Mag.*, vol. 45, no. 9, pp. 106–112, Sep. 2007.
- [3] W. Chiang, W. Chang, and L. Liu, "Simultaneous handover support for mobile networks on vehicles," in *Proc. IEEE WCNC*, Mar. 2008, pp. 2771–2776.
- [4] Z. Zhang, A. Boukerche, and R. Pazzi, "A novel network mobility management scheme for vehicular networks," in *Proc. IEEE GLOBECOM*, Dec. 2010, pp. 1–5.
- [5] A. Lera, A. Molinaro, S. Polito, and G. Ruggieri, "End-to-end QoS provisioning in 4G with mobile hotspots," *IEEE Netw.*, vol. 19, no. 5, pp. 26–34, Sep./Oct. 2005.
- [6] D. Niyato and E. Hossain, "Integration of IEEE 802.11 WLANs with IEEE 802.16-based multihop infrastructure mesh/relay networks: A game-theoretic approach to radio resource management," *IEEE Netw.*, vol. 21, no. 3, pp. 6–14, May/June 2007.
- [7] J. Wang, Y. Hsu, and C. Tseng, "A bandwidth-sharing reservation scheme to support QoS for network mobility," in *Proc. IEEE ICC*, Jun. 2006, pp. 693–698.
- [8] C. Lee, Y. Sun, and M. Chen, "HiMIP-NEMO: Combining cross-layer network mobility management and resource allocation for fast QoS-handovers," in *Proc. IEEE VTC Spring*, May 2008, pp. 2282–2286.
- [9] E. Perera, H. Petander, K. Lan, and A. Seneviratne, "An implementation and evaluation of a mobile hotspot," in *Proc. WMASH*, Sep. 2005, pp. 104–106.
- [10] W. Song and W. Zhuang, "Resource reservation for self-similar data traffic in cellular/WLAN integrated mobile hotspots," in *Proc. IEEE ICC*, May 2010, pp. 1–5.
- [11] S. Pack, X. Shen, J. Mark, and L. Cai, "Throughput analysis of TCP-friendly rate control in mobile hotspots," *IEEE Trans. Wireless Commun.*, vol. 7, no. 1, pp. 193–203, Jan. 2008.
- [12] S. Pack, H. Rutagemwa, X. Shen, J. Mark, and L. Cai, "Performance analysis of mobile hotspots with heterogeneous wireless links," *IEEE Trans. Wireless Commun.*, vol. 6, no. 10, pp. 3717–3727, Oct. 2007.
- [13] Y. Kim, J. Ko, W. Kim, and S. Pack, "A measurement study on Internet access in vehicular Wi-Fi networks," in *Proc. IEEE VTC Fall*, Sep. 2010, pp. 1–5.
- [14] I. Soto, C. Bernardos, M. Calderon, A. Banchs, and A. Azcorra, "NEMO-enabled localized mobility support for Internet access in automotive scenarios," *IEEE Commun. Mag.*, vol. 47, no. 5, pp. 152–159, May 2009.
- [15] M. Ahmed, "Call admission control in wireless networks: A comprehensive survey," *IEEE Commun. Surveys Tuts.*, vol. 7, no. 1, pp. 49–68, First Quarter 2005.
- [16] H. Liao, X. Wang, and H. Chen, "Adaptive call admission control for multi-class services in wireless networks," in *Proc. IEEE ICC*, May 2008, pp. 2840–2844.
- [17] S. Lee, K. Kim, K. Hong, D. Griffith, Y. Kim, and N. Golmie, "A probabilistic call admission control algorithm for WLAN in heterogeneous wireless environment," *IEEE Trans. Wireless Commun.*, vol. 8, no. 4, pp. 1672–1676, Apr. 2009.
- [18] E. Navarro, A. Mohsenian-Rad, and V. Wong, "Connection admission control for multiservice integrated cellular/WLAN system," *IEEE Trans. Veh. Technol.*, vol. 57, no. 6, pp. 3789–3800, Nov. 2008.
- [19] L. X. Cai, X. Shen, J. Mark, L. Cai, and Y. Xiao, "Voice capacity analysis of WLAN with unbalanced traffic," *IEEE Trans. Veh. Technol.*, vol. 55, no. 3, pp. 752–761, May 2006.
- [20] Y. Fang and Y. Zhang, "Call admission control schemes and performance analysis in wireless mobile networks," *IEEE Trans. Veh. Technol.*, vol. 51, no. 2, pp. 371–382, Mar. 2002.
- [21] J. Choi, B. Choi, Y. Kim, and S. Pack, "Call admission control for mobile hotspot," in *Proc. QTNA*, Seoul, Korea, Aug. 2011.
- [22] P. Lin, W. Lai, and C. Gan, "Modeling opportunity driven multiple access in UMTS," *IEEE Trans. Wireless Commun.*, vol. 3, no. 5, pp. 1669–1677, Sep. 2004.
- [23] L. Kleinrock, *Queueing Systems: Theory*. New York, NY, USA: Wiley, 1975.
- [24] A. L. Garcia, *Probability, Statistics, and Random Processes for Electrical Engineering*, 3rd ed. Englewood Cliffs, NJ, USA: Prentice-Hall, 2009.



Younghyun Kim received the B.S. and M.S. degrees in computer engineering from Soongsil University, Seoul, Korea, in 2005 and 2007, respectively, and the Ph.D. degree from Korea University, Seoul, in 2013.

From 2007 to 2008, he was a Software Engineer with Celrun Inc., Seoul. His research interests include mobility management, Future Internet, and quality-of-service provision issues in next-generation wireless/mobile networks.



Haneul Ko received the B.S. degree from Korea University, Seoul, Korea, in 2011. He is currently working toward the integrated M.S./Ph.D. degree with the School of Electrical Engineering, Korea University.

His research interests include mobility management and Future Internet.



Sangheon Pack (SM'11) received the B.S. (*magna cum laude*) and Ph.D. degrees in computer engineering from Seoul National University, Seoul, Korea, in 2000 and 2005, respectively.

From 2005 to 2006, he was a Postdoctoral Fellow with the Broadband Communications Research Group, University of Waterloo, Waterloo, ON, Canada. Since 2007, he has been with Korea University, Seoul, where he is currently an Associate Professor with the School of Electrical Engineering. His research interests include mobility management,

wireless multimedia, vehicular networks, and Future Internet.

Dr. Pack is an Editor for the *Journal of Communications Networks*. He received the IEEE Communications Society Asia-Pacific Board Outstanding Young Researcher Award in 2009.



Wonjun Lee (SM'06) received the B.S. and M.S. degrees in computer engineering from Seoul National University, Seoul, Korea, in 1989 and 1991, respectively; the M.S. degree in computer science from the University of Maryland, College Park, MD, USA, in 1996; and the Ph.D. degree in computer science and engineering from the University of Minnesota, Minneapolis, MN, USA, in 1999.

Since 2002, he has been with Korea University, Seoul, where he is currently a Professor with the Department of Computer Science and Engineering and a Director with the World Class University Future Network Optimization Technology Center and the Future Network Center. He is the author or coauthor of over 123 papers in refereed international journals and conferences. His research interests include mobile wireless communication protocols and architectures, cognitive radio networking, and vehicular ad hoc networks.



Xuemin (Sherman) Shen (F'09) received the B.Sc. degree from Dalian Maritime University, Dalian, China, in 1982 and the M.Sc. and Ph.D. degrees from Rutgers University, Camden, NJ, USA, in 1987 and 1990, all in electrical engineering.

He is currently a Professor and a University Research Chair with the Department of Electrical and Computer Engineering, University of Waterloo, Waterloo, ON, Canada. His research interests include resource management in interconnected wireless/wired networks, wireless network security, wireless body area networks, vehicular ad hoc networks, and sensor networks.

Dr. Shen serves or has served as the Editor-in-Chief for *IEEE Network*, *Peer-to-Peer Networking and Application*, and *Institution of Engineering and Technology Communications*; as a Founding Area Editor for the IEEE TRANSACTIONS ON WIRELESS COMMUNICATIONS; as an Associate Editor for the IEEE TRANSACTIONS ON VEHICULAR TECHNOLOGY, *Computer Networks*, and *ACM/Wireless Networks*, etc.; and as the Guest Editor for the IEEE JOURNAL ON SELECTED AREAS IN COMMUNICATIONS, *IEEE Wireless Communications*, *IEEE Communications Magazine*, the *Association of Computer Machinery Mobile Networks and Applications*, etc.

Dr. Shen is a registered Professional Engineer in Ontario, Canada; a Fellow of the Engineering Institute of Canada; a Fellow of the Canadian Academy of Engineering; and a Distinguished Lecturer of the IEEE Vehicular Technology and Communications Societies.